

LIGHT BOOK

ELTOR
IDEAS IN LIGHTING

LIGHT BOOK

ARTS & ARCHITECTURE
LIVING SPACE APPLICATIONS
ACCOMMODATION & TOURISM

www.eltor.hr • www.eltorlighting.com

ISO 9001
BUREAU VERITAS
Certification



Sadržaj

TABLE OF CONTENT

UVOD / INTRO	2
ANTIGONE	9
SFERA	19
NEW SUN	25
ICON	27
PLAT	39
STYLE	43
AURA	49
GREEK	53
CIRCOLINA	57
LINE	61
GERCIO	65
TISS	69
PUNTA	71
FLAME	77
ELTRACK	81
STAR SKY	83
HALO	85
COIN	87
FLASH	91
QUADRIC	99
EDGE	101
EDRA	105
EDEN	110
ECOS	113
WINDY	115
SMOOTH	119
ARCA	123
PLAIN	131
LS 50	137
SIDE	141
AF	145
PROFILES	147
LITE	159
LED LINE F	161
MIRAGE	163
STATE	165
PROFESIONALNA RJEŠENJA / PROFFESIONAL SOLUTIONS	173
NAPAJANJA / POWER SUPPLIES	176
LEGENDA / LEGENDS	177
UPUTE ZA NARUČIVANJE / ORDERING INSTRUCTIONS	180
INDEX	181

▼
Ambijentalna
rasvjeta
*Ambiental
lighting*



ANTIGONE
10



ANTIGONE
SUSPENDED
16

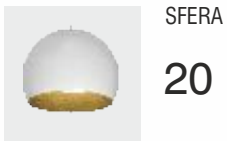

SFERA
20

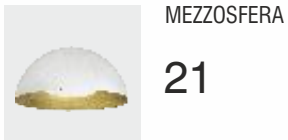

MEZZOSFERA
21



SFERA RIGID
22



TORIO
23



DROP
24



NEW SUN
DECO
26

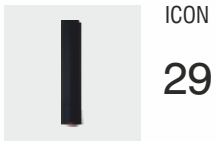

ICON
29

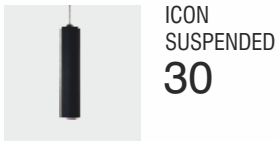

ICON
SUSPENDED
30

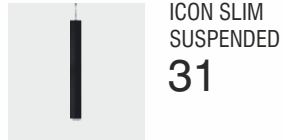

ICON SLIM
SUSPENDED
31



ICON
SINGLE
32

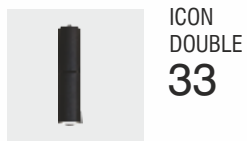

ICON
DOUBLE
33



ICON 200
34



ICON
WALL
35



ICON
TABLE
37



PLAT
41



STYLE
44



STYLE
DOUBLE
46

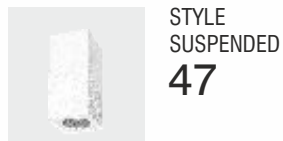

STYLE
SUSPENDED
47



STYLE
D/I
48



AURA
50



AURA AP
51



GREEK
54

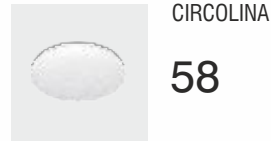

CIRCOLINA
58

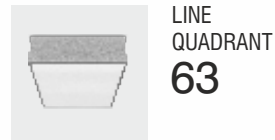

LINE
QUADRANT
63

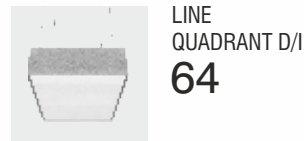

LINE
QUADRANT D/I
64



CERCIO
67

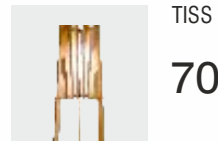

TISS
70



PUNTA
WALL
73



PUNTA
TABLE
74

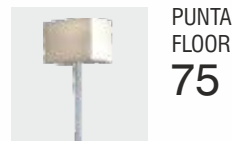

PUNTA
FLOOR
75

▼
Spotlight
Spotlights

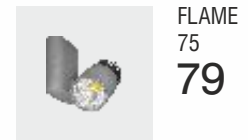

FLAME
75
79

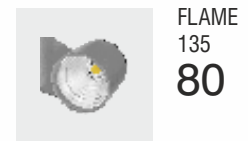

FLAME
135
80



ELTRACK
82

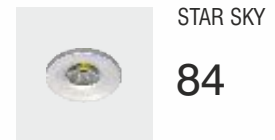

STAR SKY
84

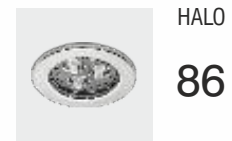

HALO
86

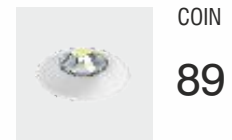

COIN
89



COIN
MAXI
90

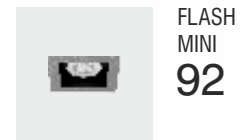

FLASH
MINI
92

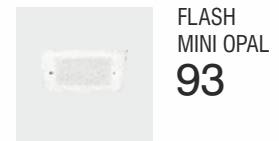

FLASH
MINI OPAL
93

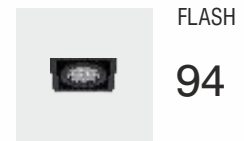

FLASH
94



FLASH 2

95



FLASH 3

97



FLASH 4

98



QUADRIC

100



Downlighteri
Downlights



EDGE
SQUARE

103



EDGE
ROUND

104



EDRA

106



EDEN

111



ECOS

114



WINDY

116



Svjetiljke bez
vidljivog ruba
Trimless
luminaires



SMOOTH
ROUND

120



SMOOTH
SQUARE

121



SMOOTH
MAXI

122

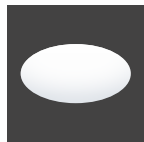

ANTIGONE
RECESSED

17



ARCA
SQUARE

124



ARCA
SQUARE UP

126



ARCA
RECTANGLE

127



ARCA
RECTANGLE SLIM

128

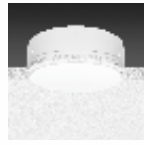

ARCA
ROUND

129



ARCA
ROUND UP

130



Profilne
svjetiljke
Profile
luminaires



PLAIN

132



PLAIN
RECESSED

134

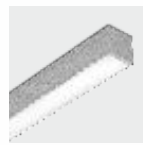

LS 50

138



SIDE

142

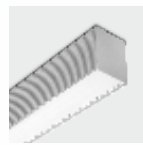

SIDE OP

143

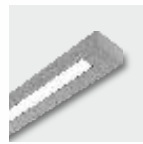

LINE SLIM
WALL

62



AF

146



PROFILES

147



HAVEN

154

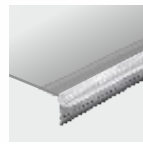

STEPLINE

155



STEPLINE
CARPET

157



LED
STRIPS

158



Vanjska
rasvjeta
Outdoor
lighting



LITE

160

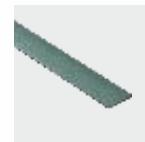

LED
LINE F

162



MIRAGE

164



STATE
WALL

166



STATE
MINI

167



STATE

170



STATE
DOUBLE

171



STATE
DOUBLE T

172

Vremeplov

History

Tvrtka ELTOR osnovana je davne 1976. godine, a osnovnu djelatnost tvrtke činila je proizvodnja toroidnih transformatora. Nakon niza godina konstantnog i kontinuiranog razvoja, danas tvrtka ELTOR predstavlja jednog od renomiranih i svjetski poznatih proizvođača rasvjetne opreme.

ELTOR d.o.o. Ušao je u segment brodske rasvjete i posjeduje kompletne antivibracijske, požarne i elektro ateste te smo kao takvi ušli u brodski registar 2009. godine. Tvrtka koja nas je pratila je Bureau Veritas.

ELTOR COMPANY was founded in 1976. The core business consisted of the production of toroidal transformers. After lots of years of continuous development, the company today represents a renowned and recognized manufacturer of electrical equipment.

In the year of 2009, the company was registered in the shipping register and owns the complete antivibrating, fire and electronic certificates in the segment. The regulating partner was Bureau Veritas



osnovan ELTOR kao obrtničko poduzeće	1976.	<i>founded ELTOR as a craft association</i>
Zbog novog zakona, tvrtka postaje d.o.o	1990.	<i>Due to a new law, ELTOR becomes a company</i>
Povećanjem proizvodnje, otvara se novi, moderni proizvodni pogon	2003.	<i>Thanks to an increased productivity a new, modern manufacturing facility is open</i>
Zbog povećane potražnje za ELTORovim proizvodima, tvrtka proširuje i postrojenje	2008.	<i>Due to an increased demand for ELTOR products, the facility is expanded</i>
Uvođenje certifikata ISO 9001:2008 i ulazak ELTOR-a u brodski registar	2009.	<i>The introduction of the ISO 9001: 2008 and ELTOR's entry into ship register</i>
Dizajnirana nova serija proizvoda i implementacija LED tehnologije	2010.	<i>New line of luminaires designed and implementation of LED technology</i>
Dizajnirane nove trimless svjetiljke u klasičnoj i LED verziji	2011.	<i>New Trimless luminaires designed in classic and LED variant</i>
Nova serija hotelske rasvjete	2012.	<i>New line of luminaires for hospitality industry</i>
Ulazak na nova, internacionalna tržišta - Dubai, Rusija, Izrael	2013.	<i>Entry to new, international markets - Dubai, Russia, Israel</i>
Nova napredna svjetiljka "EDGE" je razvijena	2015.	<i>New advanced luminaire "EDGE" is produced</i>

Led tehnologija

Led technology

Od ideje do svjetleće stvarnosti...

LED je akronim od LIGHT EMITTING DIODE, komponente koja emitira monokromatsko svjetlo kao posljedicu protoka električne struje.

LED predstavljaju novi alat u radu dizajnera rasvjete i omogućuju stvaranje novih maštovitih proizvoda sa iznenađujućim efektima, koji su nekoć bili tehnički neizvedivi.

Po prvi puta napredak LED tehnologije omogućio je postizanje visoke kvalitete boje kao i neutralno bijelog osvjetljenja, kao za unutarnju tako i za vanjsku primjenu.

Sedmero-bojni LED i bijeli LED visoke snage postali su dostupni u posljednjih nekoliko godina, napredak je također postignut u području plastičnih i silikonskih leća koje omogućuju dugotrajni životni vijek LED-a s visokim očuvanjem razine svjetlosnog toka.

Tijekom prošle godine na tržištu se pojavljuju i visoko-kvalitetne LED diode sa toplo bijelim osvjetljenjem, temperaturom osvjetljenja 3200K i odličnim indeksom uzvrata boje RA 90. Svjetlost, ujednačenost boje i kromatsko područje LED-a su znatno poboljšani, u tolikoj razini da su danas LED moduli sve više korišteni za osvjetljenje u klasičnim interijerima kao i mnogim drugim područjima.

RGB modul
RGB module

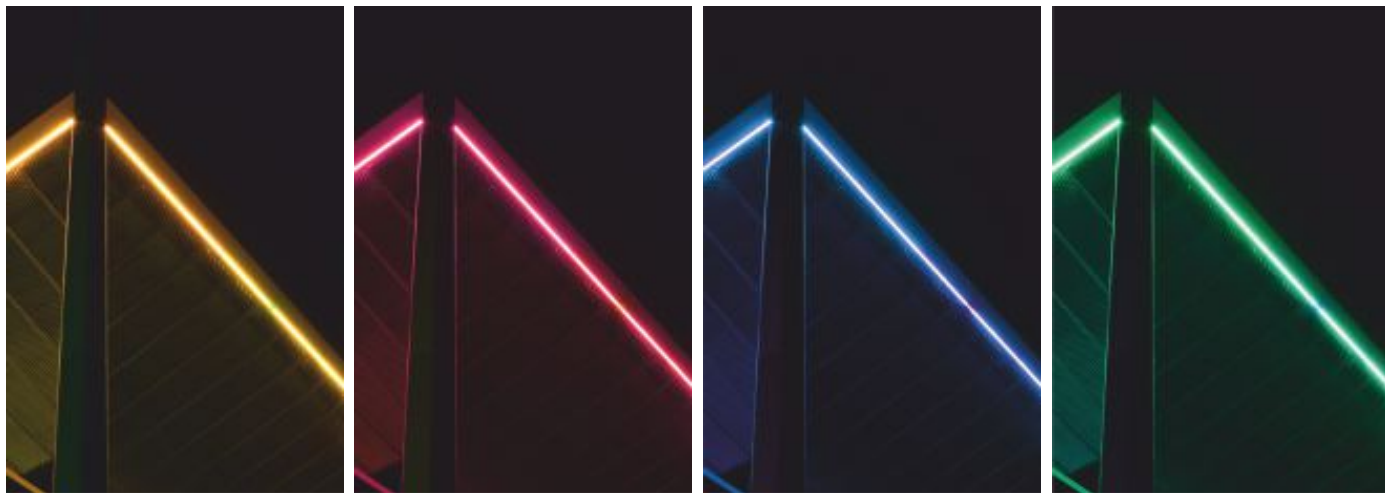

From idea to lighting reality...

LED stands for light emitting diode, that emits monochromatic light as a result of the flow of electricity.

LEDs represent a new tool in the work of lighting designers and allow the creation of imaginative new products with amazing effects, which were once technically unfeasible. For the first time the progress of LED technology has made it possible to achieve high quality color and a neutral white light, for indoor and outdoor use.

Seven-color LED and high power white LEDs have become available in recent years, progress was also achieved in the field of plastic and silicone cover-lenses, which allow long lifetime of LEDs with a high conservation level of intensity.

Over the last year on the market appear to high-quality LEDs with a warm white light, 3200K temperature and excellent color index retribution RA 90, color uniformity and chromatic area LED's are much improved, to such a degree that today the LED modules are increasingly used to illuminate the classical interiors as well as many other areas.

Svjetlo koje motivira

Light that motivates

Prava svjetlost u pravom trenutku

Svjetlost je osnovna komponenta u planiranju interijera a razina ekonomičnosti i ugodnosti je jedan od najbitnijih elemenata kako za osoblje ili djelatnike tako i za goste odnosno klijente vaših interijera.

Prava rasvjeta omogućava optimalne vizualne uvjete i stvara efikasan i motivirajući ambijent dok istovremenu atraktivno djeluje na izgled samog prostora.

Individualni prostori interijera mogu biti zasebno osmišljeni u smislu svjetlosnog dizajna te time stvarati atmosferu koja je potrebna odnosno poželjna u pojedinim prostorima.

The right light in the right moment

Lighting is an integral component when planning interior and levels of economy and comfort are some of the most important factors both for the employers and customers of your interiors.

The right light assures optimal visual conditions, creates an efficient and motivating work atmosphere and also serves as an attractive element of design.

Optimal ergonomic and economic lighting solutions can be flexibly modified according to individual work areas and requirements.

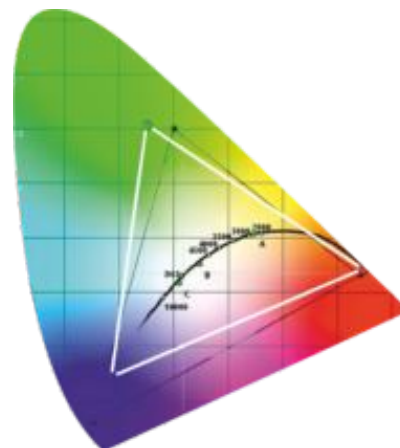
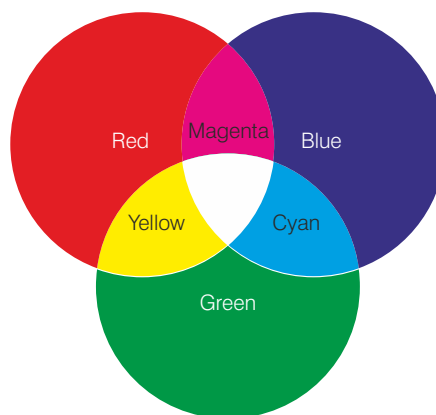

Temperatura svjetlosti (K) Color temperature (K)	2700K-3000K	3500K-4100K	5500K-6500K
Boja svjetlosti <i>Light color</i>	Topla / mekano bijela <i>Warm/soft white</i>	Hladna, blještavo bijela <i>Cool, bright white</i>	Dnevna svjetlost <i>Daylight</i>
Atmosfera <i>Mood created</i>	Ugodna, opuštajuća <i>Relaxing, comfortable</i>	Čista, živahna <i>Clean, lively</i>	Osvježavajuća, energična <i>Refreshing, energetic</i>
Upotreba <i>Uses</i>	Dnevni boravci, sobe <i>Living rooms, bedroom</i>	Kuhinje, uredi <i>Kitchen, office</i>	Čitanje i zadaci <i>Reading and tasks</i>

Atmosfera na dodir prsta

Atmosphere at the touch of your finger

Osvjetljavanje prostora, osvjetljavanje života

Dobra rasvjeta je potrebna za dobar rad, a koncentracija se postiže i drži lakoćom u dobrim svjetlosnim uvjetima. Također, ugodna rasvjeta omogućuje bolju motivaciju i osjećaj zadovoljstva.

Efektna i pametna rasvjeta daje veliki doprinos u svim prostorima. Kombinacija hladnije svjetlosti i indirektna rasvjeta izrazito povoljno djeluje na efekt zadovoljstva u interijerima te samim time smanjuje osjećaj umora.

Dinamičko osvjetljenje sa stupnjevima rasvijete te sensorima pokreta i danjeg svijetla omogućuje klijentima da koriste svjetlost kako bi poboljšali radnu okolinu te uštedjeli na električnoj energiji.

illuminating space, illuminating life

Good light is needed for good work, and concentration becomes easier with good visual conditions. A pleasant light atmosphere also makes sure of more well-being and motivation.

Biologically effective light makes a valuable contribution in such situations, meaning on the one hand light with higher blue components/colour temperatures and on the other, indirect light distribution.

Dynamic light with levels of brightness and light colours modified according to the course of the day support the natural biological rhythm, thus in turn increasing well-being and performance capability.

Dimenzije kvalitete rasvijete Dimensions of light quality

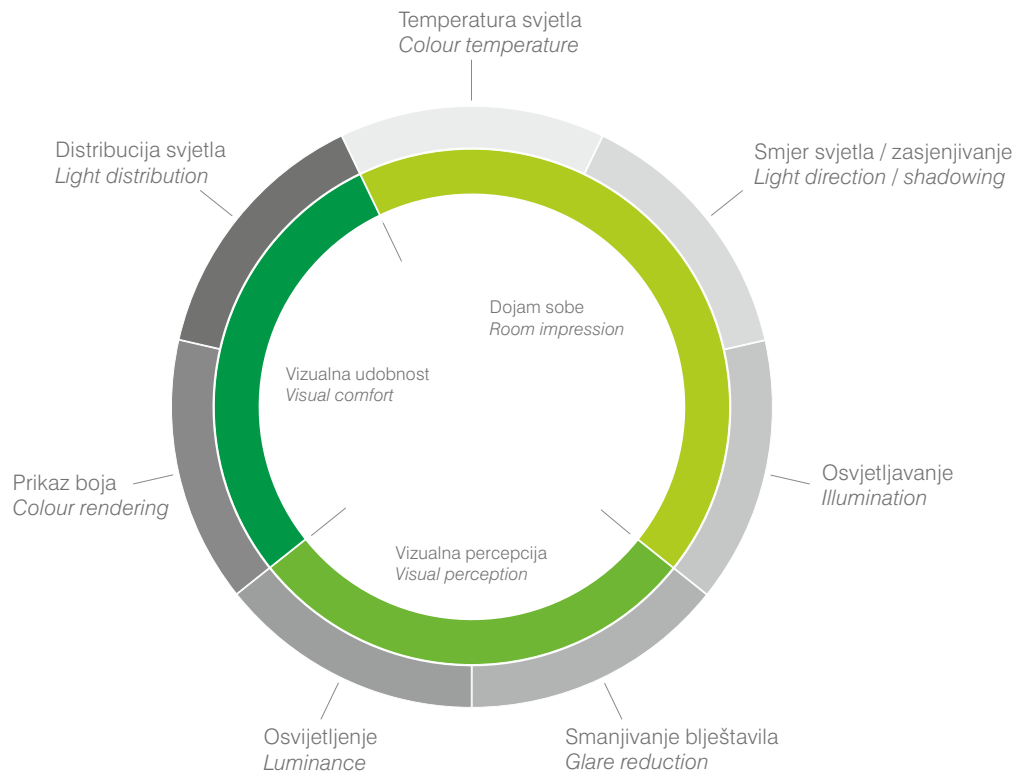

Učinkovitost i ušteda

Efficiency and energy saving

Prava rasvjeta ne mora biti skupa

Energetski učinkovite tehnologije i inteligentna rasvjetna tijela smanjuju potrošnju energije bez smanjivanja kvalitete svijetla, a istovremeno se smanjuje operativni trošak i poboljšava okolinu.

To je jedan od glavnih razloga radi kojeg se preporučuje obnova rasvjete u većini interijera, da li zbog uštede energije ili zbog usklađivanja s propisima.

Preporučamo LED i fluo cijevi, ovisno o zahtjevima projekta. Koje su želje i/ili zahtjevi kupaca?

Da li su planiranja na kratkotrajnoj ili dugotrajnoj bazi? Investicijski troškovi i ušteda u potrošnji energije se na kraju uspoređuju.

The right lighting doesn't have to be expensive

Energy-optimised technologies and intelligent Lighting Tools reduce energy consumption without the need to compromise on light quality, relieve the environment and reduce operating costs.

It is mainly for this reason that the refurbishment of lighting in many interiors is highly recommended, whether to cut electricity and maintenance costs or to comply with legislation.

We fundamentally recommend LEDs and T16 fluorescent lamps depending on the specific project. What are customer desires and requirements? Is planning for the short-term or long-term? Investment costs and saved energy costs are ultimately compared.

Dimenzije kvalitete rasvjete
Dimensions of light quality

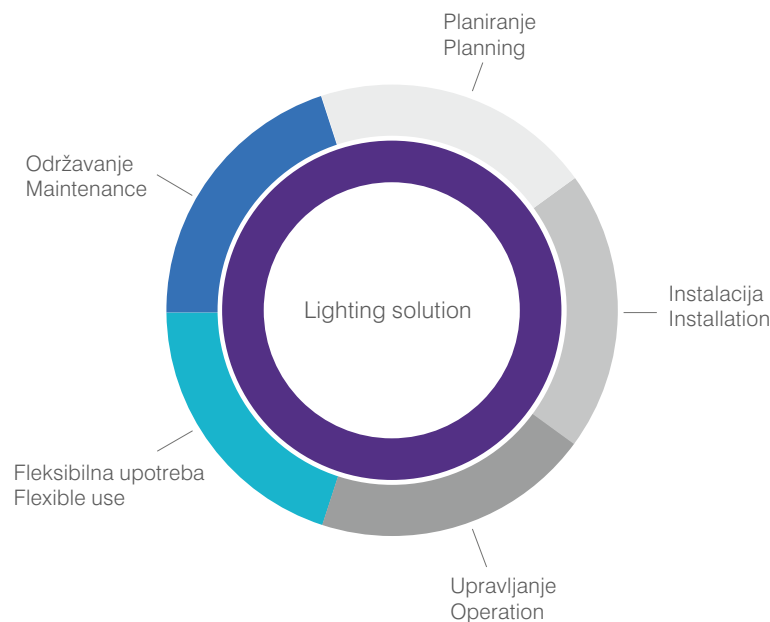

ELTOR
IDEAS IN LIGHTING

LIGHT BOOK

ISO 9001

BUREAU VERITAS
Certification





Antigone

Dekoratívna svjetiljka kružnog geometrijskog oblika te inovativnog dizajna, linija svjetiljaka Antigone pogodna je za osvjetljavanje različitih dekorativnih prostora. Opalni polikarbonatni difuzor homogenog efekta oplemenjuje svjetiljku svojim visokim stupnjem uniformiranosti svjetlosnog toka tehnologije "crystal ice". Različitih promjera od 350 mm do 1200 mm pružaju mogućnost visokoga stupnja slobode dizajniranja rasvjete stapajući se s prostorom te postajući njegov sastavni dio.

Decorative and innovative lamp with circular geometric shape, Antigone lamp lines are optimal for illuminating a variety of decorative spaces.

Opal polycarbonate diffuser with soft effect enriches the lamp with its uniform luminous flux made possible by "crystal ice" technology.

Dimensions from 350 mm to 1200 mm offer the freedom of light design and allow the lamps to seamlessly blend into any space and become its essential part.

NAMJENA / USAGE



Antigone

Nadgradna/zidna LED svjetiljka / Surface/wall mounted LED lamp



BIJELA/WHITE (W)



SIVA/GREY (G)



CRNA/BLACK (B)

Kućište: ekstrudirani aluminij obojan termoeпокsidnom bojom

Standardna fino strukturna boja: bijela, siva, crna

Napajanje: 230V/50Hz

Električne komponente: ugrađene u kućište

Izvor svjetla: LED generacije 3, self-cooling, MacAdam 3 CRI>80; LED min 60.000h L80F50 na $T_p=65^{\circ}\text{C}$; EEI A++

Diffuzor: protublješćeci opalni homogenog efekta tehnologije "Crystal Ice"

Montaža: pomoću vijaka na strop/zid

Spajanje: skidanjem obruča dostupne su priključne stezaljke i ostale električne komponente

Prema zahtjevu: panik, regulacijska jedinica DALI, DIM, RGB (vidi upute za naručivanje str. 180)

Housing: extruded aluminium covered with thermal epoxy colour

Standard finely-textured color: white, gray, black

Power: 230V/50Hz

Supply unit: built in the housing

Light source: LED generation 3, self-cooling; MacAdam 3 CRI>80; LED min 60.000h L80F50 on $T_p=65^{\circ}\text{C}$. EEI A++

Diffuser: anti-glare opal with homogenous effect with "Crystal Ice" technology

Mounting: with screws to the ceiling/wall

Connecting: through removing the rim, connection clamps and all other electronic components are available

On request: emergency light, regulation unit DALI, DIM, RGB (see ordering instructions on pg. 180)



Prema zahtjevu:
On request:

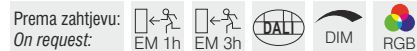

Art.	W	K	V	lm	x H	kg
ANTIGONE SMALL						
4441731	18,3W	3K/4K	230V	2600/2840	350x100	5,0
4441732	29,2W	3K/4K	230V	3750/4090	350x100	5,0
ANTIGONE MINI						
4441741	25,0W	3K/4K	230V	3427/3597	440x100	7,8
4441742	35,0W	3K/4K	230V	4798/5036	440x100	7,8
ANTIGONE MIDI						
4441761	60,2W	3K/4K	230V	8960/9240	640x100	10,0
4441763	86,8W	3K/4K	230V	11760/12180	640x100	10,0
ANTIGONE MAXI						
4441781	77,4W	3K/4K	230V	11520/11880	800x100	12,9
4441783	111,6W	3K/4K	230V	15120/15660	800x100	12,9
ANTIGONE MAXI XL*						
4441710	116,1W	3K/4K	230V	17280/17820	1200x100	19,3
4441716	167,4W	3K/4K	230V	22680/23490	1200x100	19,3

* Dostupna samo stropna izvedba
Only ceiling version available



ANTIGONE MIDI art. 4441761

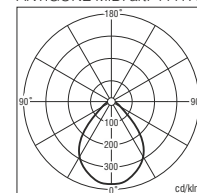



PROJECT: Raiffeisen bank zagreb
PHOTOGRAPHER: Eltor

Antigone

Nadgradna/zidna svjetiljka / Surface/wall mounted lamp



BIJELAWHITE (W)

SIVA/GREY (G)

CRNA/BLACK (B)

Art.		W	V	x H	kg
ANTIGONE SMALL					
4441218	TC-L 2x18W	230V	350x100	5,0	
4441040	FC T5 55W	230V	350x100	5,0	
ANTIGONE MINI					
4441055	FC T5 55W	230V	440x100	7,8	
4441324	TC-L 3x24W	230V	440x100	7,8	
ANTIGONE MIDI					
4441892	TC-L 2x18W + T5 4x14W	230V	640x100	10,0	
4441194	TC-L 2x24W + T5 4x24W	230V	640x100	10,0	
ANTIGONE MAXI					
4441614	T5 6x14W	230V	800x100	12,9	
4441624	T5 6x24W	230V	800x100	12,9	
ANTIGONE MAXI XL*					
4441821	TC-L 2x18W + T5 2x14W + T5 5x21W	230V	1200x100	19,3	
4441839	TC-L 2x24W + T5 2x24W + T5 5x39W	230V	1200x100	19,3	

* Dostupna samo stropna izvedba
Only ceiling version available

Kućište: ekstrudirani aluminij obojan termoeпокsidnom bojom

Standardna fino strukturna boja: bijela, siva, crna

Napajanje: 230V/50Hz

Električne komponente: ugrađene u kućište

Izvor svjetla: fluo T5 i Dulux L cijevi

Difuzor: protublješteći opalni homogenog efekta tehnologije "Crystal Ice"

Montaža: pomoću vijaka na strop/zid

Spajanje: skidanjem obruča dostupne su priključne stezaljke i ostale električne komponente

Prema zahtjevu: panik, regulacijska jedinica DALI, DIM (vidi upute za naručivanje str. 180)

Housing: extruded aluminium covered with thermal epoxy colour

Standard finely-textured color: white, gray, black

Power: 230V/50Hz

Supply unit: built in the housing

Light source: fluo T5 and Dulux L bulbs

Diffuser: anti-glare opal with homogenous effect with "Crystal Ice" technology

Mounting: with screws to the ceiling/wall

Connecting: through removing the rim, connection clamps and all other electronic components are available

On request: emergency light, regulation unit DALI, DIM (see ordering instructions on pg. 180)



Prema zahtjevu:
On request:



ANTIGONE MINI art. 4441324

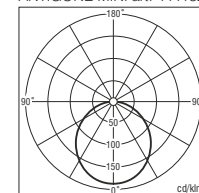

Antigone

Viseća LED svjetiljka / Suspended LED lamp



BIJELA/WHITE (W)

SIVA/GREY (G)

CRNA/BLACK (B)

Art.	W	K	V	lm	x H	kg
ANTIGONE SMALL						
4443731	18,3W	3K/4K	230V	2600/2840	350x100	5,0
4443732	29,2W	3K/4K	230V	3750/4090	350x100	5,0
ANTIGONE MINI						
4443741	25,0W	3K/4K	230V	3427/3597	440x100	7,8
4443742	35,0W	3K/4K	230V	4798/5036	440x100	7,8
ANTIGONE MIDI						
4443761	60,2W	3K/4K	230V	8960/9240	640x100	10,0
4443763	86,8W	3K/4K	230V	11760/12180	640x100	10,0
ANTIGONE MAXI						
4443781	77,4W	3K/4K	230V	11520/11880	800x100	12,9
4443783	111,6W	3K/4K	230V	15120/15660	800x100	12,9
ANTIGONE MAXI XL						
4443710	116,1W	3K/4K	230V	17280/17820	1200x100	19,3
4443716	167,4W	3K/4K	230V	22680/23490	1200x100	19,3

Kućište: ekstrudirani aluminij obojan termoeпокsidnom bojom

Standardna fino strukturna boja: bijela, siva, crna

Napajanje: 230V/50Hz

Električne komponente: ugrađene u kućište

Izvor svjetla: LED generacije 3, self-cooling, MacAdam 3 CRI>80; LED min 60.000h L80F50 na $T_p=65^{\circ}\text{C}$; EEL A++

Difuzor: protublješteći opalni homogenog efekta tehnologije "Crystal Ice"

Montaža: pomoću visilica s auto blok sustavom, max L=1500mm (u kompletu)

Spajanje: skidanjem obruča dostupne su priključne stezaljke i ostale električne komponente

Prema zahtjevu: panik, regulacijska jedinica DALI, DIM, direktno-indirektna rasvjeta, RGB (vidi upute za naručivanje str. 180)

Housing: extruded aluminium covered with thermal epoxy colour

Standard finely-textured color: white, gray, black

Power: 230V/50Hz

Supply unit: built in the housing

Light source: LED generation 3, self-cooling; MacAdam 3 CRI>80; LED min 60.000h L80F50 on $T_p=65^{\circ}\text{C}$. EEL A++

Diffuser: anti-glare opal with homogenous effect with "Crystal Ice" technology

Mounting: hanging on steel suspension with auto block system, max L=1500mm (set included)

Connecting: through removing the rim, connection clamps and all other electronic components are available

On request: emergency light, regulation unit DALI, DIM, direct-indirect light, RGB (see ordering instructions on pg. 180)

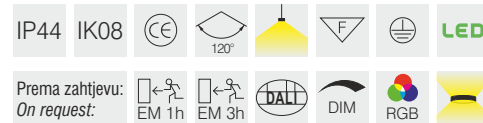

125/100x25 mm
ukrasna rozeta s prozirnim
dekorativnim kabelom 6 mm
3x0,75mm², L=1500 mm

125/100x25 mm
decorative box with decorative
transparent cable 6 mm
3x0,75 mm², L=1500 mm

prema zahtjevu / on request:



Direktna / Indirektna rasvjeta
prema zahtjevu
Direct/Indirect light on request

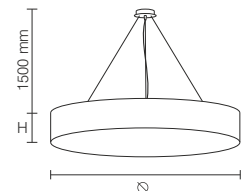

ANTIGONE MINI art. 4443741

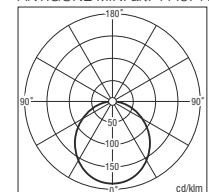



PROJECT: OLIVE HOUSE
ARCHITECTS: Tea Horvat, Radovan Šobat / Log-urbis
PHOTOGRAPHER: Robert Leš



Antigone suspended

Viseća svjetiljka / *Suspended lamp*

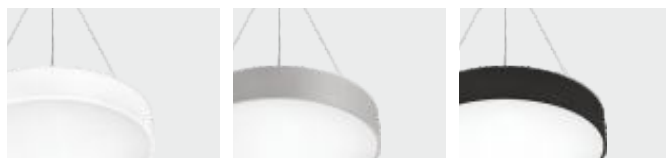

BIJELAWHITE (W)

SIVA/GREY (G)

CRNA/BLACK (B)

Art.	W	V	x H	kg
ANTIGONE SMALL				
4443218	TC-L 2x18W	230V	350x100	5,0
4443040	FC T5 55W	230V	350x100	5,0
ANTIGONE MINI				
4443055	FC T5 55W	230V	440x100	7,8
4443324	TC-L 3x24W	230V	440x100	7,8
ANTIGONE MIDI				
4443892	TC-L 2x18W + T5 4x14W	230V	640x100	10,0
4443194	TC-L 2x24W + T5 4x24W	230V	640x100	10,0
ANTIGONE MAXI				
4443614	T5 6x14W	230V	800x100	12,9
4443624	T5 6x24W	230V	800x100	12,9
ANTIGONE MAXI XL				
4443821	TC-L 2x18W + T5 2x14W + T5 5x21W	230V	1200x100	19,3
4443839	TC-L 2x24W + T5 2x24W + T5 5x39W	230V	1200x100	19,3

Kućište: ekstrudirani aluminij obojan termoeпокsidnom bojom

Standardna fino strukturna boja: bijela, siva, crna

Napajanje: 230V/50Hz

Električne komponente: ugrađene u kućište

Izvor svjetla: fluo T5 i Dulux L cijevi

Difuzor: protubljesteći opalni polikarbonat homogenog efekta tehnologije "Crystal Ice"

Montaža: pomoću visilica s auto blok sustavom, max L=1500mm (u kompletu)

Spajanje: skidanjem obruča dostupne su priključne stezaljke i ostale električne komponente

Prema zahtjevu: panik, regulacijska jedinica DALI, DIM, direktno-indirektna rasvjeta (vidi upute za naručivanje str. 180)

Housing: extruded aluminium covered with thermal epoxy colour

Standard finely-textured color: white, gray, black

Power: 230V/50Hz

Supply unit: built in the housing

Light source: fluo T5 and Dulux L bulbs

Diffuser: anti-glare opal with homogenous polycarbonate effect with "Crystal Ice" technology

Mounting: hanging on steel suspension with auto block system, max L=1500mm (set included)

Connecting: through removing the rim, connection clamps and all other electronic components are available

On request: emergency light, regulation unit DALI, DIM, direct-indirect light (see ordering instructions on pg. 180)



Prema zahtjevu: EM 1h, EM 3h, DALI, DIM, yellow light source



125/100x25 mm
ukrasna rozeta s prozirnim
dekorativnim kabelom 6 mm
3x0,75mm², L=1500 mm

125/100x25 mm
decorative box with decorative
transparent cable 6 mm
3x0,75 mm², L=1500 mm

prema zahtjevu
on request:



Direktna / Indirektna rasvjeta
prema zahtjevu
Direct/Indirect light on request

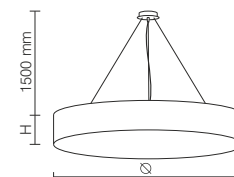

ANTIGONE MINI art. 4443055

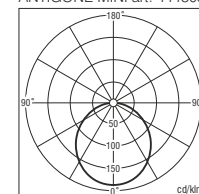

Antigone

Ugradna LED svjetiljka bez vidljivog ruba / Recessed trimless LED lamp

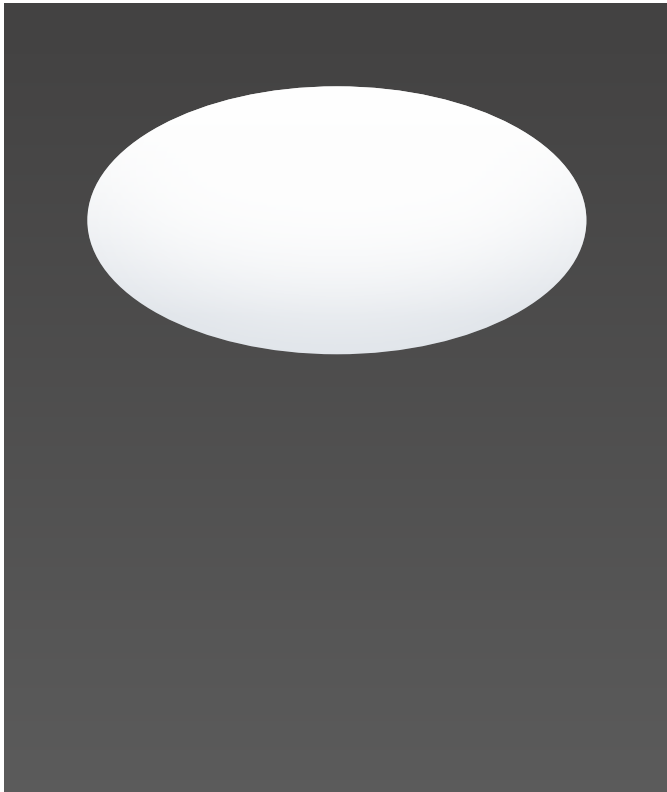

Kućište: čelični lim obojan termoeпокsidnom finostrukturnom bijelom bojom

Napajanje: 230V/50Hz

Električne komponente: ugrađene u kućište

Izvor svjetla: LED generacije 3, self-cooling, MacAdam 3 CRI>80; LED min 60.000h L80F50 na $T_p=65^{\circ}\text{C}$; EEI A++

Difuzor: protublešćeći opalni polikarbonat homogenog efekta tehnologije "Crystal Ice"

Montaža: nosačima na gips (pribor za montažu u kompletu) te gletanjem

Spajanje: skidanjem difuzora dostupne su priključne stezaljke i ostale električne komponente

Prema zahtjevu: panik, regulacijska jedinica DALI, DIM, RGB (vidi upute za naručivanje str. 180)

Housing: steel sheet-metal covered with thermal epoxy finely-textured white colour

Power: 230V/50Hz

Supply unit: built in the housing

Light source: LED generation 3, self-cooling; MacAdam 3 CRI>80; LED min 60.000h L80F50 on $T_p=65^{\circ}\text{C}$. EEI A++

Diffuser: anti-glare opal polycarbonate with homogenous effect with "Crystal Ice" technology

Mounting: with holders for plaster (in the set) and smoothing the plaster

Connecting: through removing the diffuser, connection clamps and all other electronic components are available

On request: emergency light, regulation unit DALI, DIM, RGB (see ordering instructions on pg. 180)



Art.	W	K	V	lm	x H		kg
ANTIGONE SMALL							
4442731	18,3W	3K/4K	230V	2660/2840	350x120	358	5,0
4442732	29,2W	3K/4K	230V	3750/4090	350x120	358	5,0
ANTIGONE MINI							
4442741	25,0W	3K/4K	230V	3427/3597	440x120	448	7,8
4442742	35,0W	3K/4K	230V	4798/5036	440x120	448	7,8
ANTIGONE MIDI							
4442761	60,2W	3K/4K	230V	8680/8960	640x120	648	10,0
4442763	86,8W	3K/4K	230V	11430/11810	640x120	648	10,0
ANTIGONE MAXI							
4442781	77,4W	3K/4K	230V	11160/11520	800x120	808	12,9
4442783	111,6W	3K/4K	230V	14710/15170	800x120	808	12,9

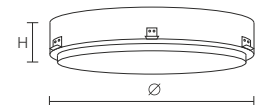

Slični proizvodi
Related products:



ARCA ROUND
Str. 129

ANTIGONE MIDI art. 4442761

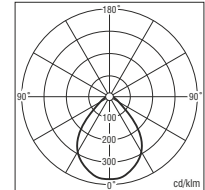

Antigone

Ugradna svjetiljka bez vidljivog ruba / *Recessed trimless lamp*

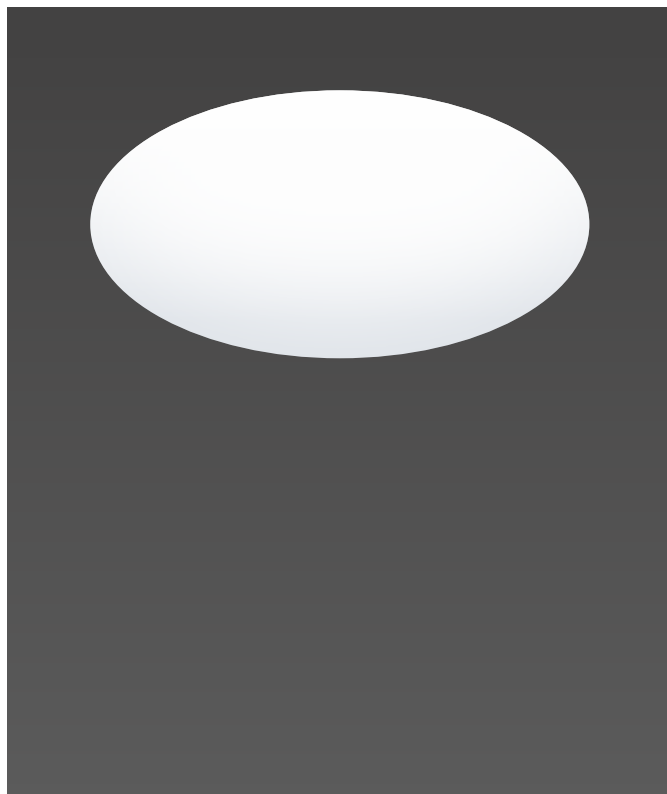

Kućište: čelični lim obojan termoeпокsidnom finostrukturnom bijelom bojom

Napajanje: 230V/50Hz

Električne komponente: ugrađene u kućište

Izvor svjetla: fluo T5 i Dulux L cijevi

Difuzor: protublješteći opalni polikarbonat homogenog efekta tehnologije "Crystal Ice"

Montaža: nosačima na gips (pribor za montažu u kompletu), gletanjem

Spajanje: skidanjem difuzora dostupne su priključne stezaljke i ostale električne komponente

Prema zahtjevu: panik, regulacijska jedinica DALI, DIM (vidi upute za naručivanje str. 180)

Housing: steel sheet-metal covered with thermal epoxy finely-textured white colour

Power: 230V/50Hz

Supply unit: built in the housing

Light source: fluo T5 and Dulux L bulbs

Diffuser: anti-glare opal polycarbonate with homogenous effect with "Crystal Ice" technology

Mounting: with holders for plaster (installation tool in the set), smoothing the plaster

Connecting: through removing the diffuser, connection clamps and all other electronic components are available

On request: emergency light, regulation unit DALI, DIM (see ordering instructions on pg. 180)



Prema zahtjevu:
On request:



Art.	W	V	x H	∅	kg
ANTIGONE SMALL					
4442218	TC-L 2x18W	230V	350x120	358	5,0
4442040	FC T5 55W	230V	350x120	358	5,0
ANTIGONE MINI					
4442055	FC T5 55W	230V	440x120	448	7,8
4442324	TC-L 3x24W	230V	440x120	448	7,8
ANTIGONE MIDI					
4442892	TC-L 2x18W + T5 4x14W	230V	640x120	648	10,0
4442194	TC-L 2x24W + T5 4x24W	230V	640x120	648	10,0
ANTIGONE MAXI					
4442614	T5 6x14W	230V	800x120	808	12,9
4442624	T5 6x24W	230V	800x120	808	12,9

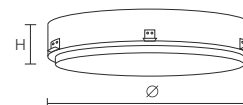

Slični proizvodi
Related products:



ARCA ROUND
Str. 129

ANTIGONE MAXI art. 4442614

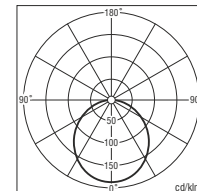



Sfera

Sfera dekorativna linija svjetiljaka sastoji se od niza visećih lampi jednostavnog dizajna predivnih linija osmišljenih kako bi naglašavali arhitektonske karakteristike prostora. Tijelo svjetiljke je od aluminija visoke čvrstoće, obojanim termoepoksidnom finostrukturnom bojom koja svojom teksturom obogaćuje svjetiljku a samim time i okolinu.

Sfera decorative line consists of a series of suspended luminaires with minimalistic and beautiful lines designed to accentuate architectural characteristics of space. The luminaire body is made from aluminium of high durability which is painted with thermal-epoxy finely structured paint which with its texture enriches the luminaire and therefore the environment .

NAMJENA / USAGE



Sfera

Viseća svjetiljka / *Suspended lamp*



BIJELA/WHITE (W)



CRNA/BLACK (B)

Art.	W	K	V	lm	xH
E27 ECO					
4363427	1xE27	3K/4K	230V		400x290
4363527	1xE27	3K/4K	230V		500x370
LED					
4363741	8,7W	3K/4K	230V	630/650	400x290
4363742	17,5W	3K/4K	230V	1300/1350	400x290
4363751	8,7W	3K/4K	230V	630/650	500x370
4363752	17,5W	3K/4K	230V	1300/1350	500x370

Kućište: aluminij obojen termoeпокsidnom bojom
Standardna vanjska fino strukturalna boja: bijela, crna
Standardna unutarnja fino strukturalna boja: bijela
Izvor svjetla: E27 ECO i LED žarulje, LED generacije 3, self-cooling, MacAdam 3 CRI>80; LED min 50.000h L70B10 na Tp=75°C; EEI A++
Napajanje: 230V/50Hz
Električne komponente: ugrađene u kućište
Difuzor: protublješteći opalni polikarbonat homogenog efekta
Montaža: vješanjem na napojni kabel
Spajanje: putem napojnog kabela

Housing: aluminium covered with thermal epoxy colour
Standard outer finely structured color: white, black
Standard inner finely structured color: white
Light source: E27 ECO and LED bulbs, LED generation 3, self-cooling; MacAdam 3 CRI>80; LED min 50.000h L70B10 on Tp=75°C. EEI A++
Power: 230V/50Hz
Supply unit: built in the housing
Diffuser: anti-glare opal diffuser with homogenous effect
Mounting: hanging on power supply cable
Connecting: through supply cable



100/80x25 mm
 ukrasna rozeta s prozirnim
 dekorativnim kabelom 6 mm
 3x0,75mm², L=1500 mm
 100/80x25 mm
 decorative box with decorative
 transparent cable 6 mm
 3x0,75 mm², L=1500 mm

prema zahtjevu
 on request:

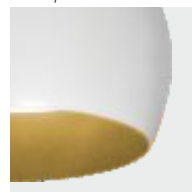

Odasijač zlatne boje
 Gold color reflector
 400 art. 681
 500 art. 682

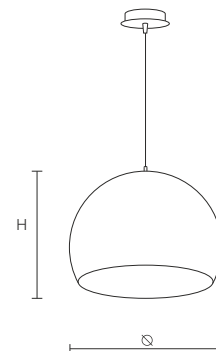

SFERA art. 4363427

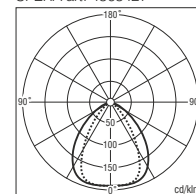

Mezzosfera

Viseća svjetiljka / *Suspended lamp*

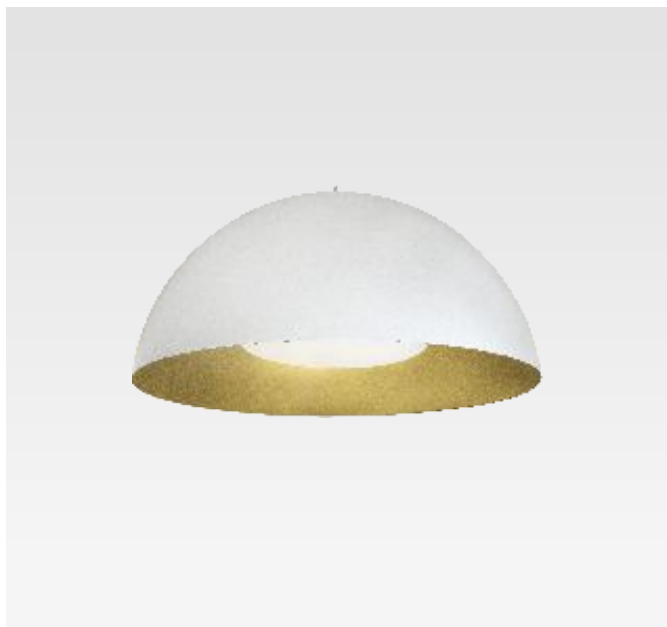

BIJELA/WHITE (W)



CRNA/BLACK (B)

Art.	W	K	V	lm	xH
E27 ECO					
4323527	1xE27	3K/4K	230V		500x370
4323727	1xE27	3K/4K	230V		720x360
LED					
4323751	8,7W	3K/4K	230V	630/650	500x370
4323752	17,5W	3K/4K	230V	1300/1350	500x370
4323771	8,7W	3K/4K	230V	630/650	720x360
4323772	17,5W	3K/4K	230V	1300/1350	720x360

Kućište: aluminij obojen termoepoksidnom bojom
Standardna vanjska fino strukturna boja: bijela, crna
Standardna unutarnja fino strukturna boja: bijela
Izvor svjetla: E27 ECO i LED žarulje, LED generacije 3, self-cooling, MacAdam 3 CRI>80; LED min 50.000h L70B10 na Tp=75°C; EEI A++
Napajanje: 230V/50Hz
Električne komponente: ugrađene u kućište
Difuzor: protubješteći opalni polikarbonat homogenog efekta
Montaža: vješanjem na napojni kabel
Spajanje: putem napojnog kabela

Housing: aluminium covered with thermal epoxy colour
Standard outer finely structured color: white, black
Standard inner finely structured color: white
Light source: E27 ECO and LED bulbs, LED generation 3, self-cooling; MacAdam 3 CRI>80; LED min 50.000h L70B10 on Tp=75°C. EEI A++
Power: 230V/50Hz
Supply unit: built in the housing
Diffuser: anti-glare opal diffuser with homogenous effect
Mounting: hanging on power supply cable
Connecting: through supply cable



100/80x25 mm
ukrasna rozeta s prozirnim
dekorativnim kabelom 6 mm
3x0,75mm², L=1500 mm
100/80x25 mm
decorative box with decorative
transparent cable 6 mm
3x0,75 mm², L=1500 mm

prema zahtjevu
on request:



Odasijač zlatne boje
Gold color reflector
500 art. 683
720 art. 684

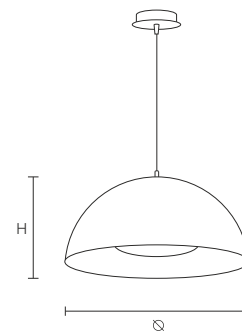

MEZZOSFERA art. 4363527

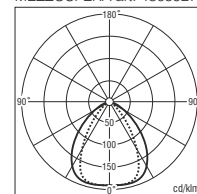

Sfera rigid

Viseća svjetiljka / *Suspended lamp*



BIJELAWHITE (W)

CRNA/BLACK (B)

Art.	W	K	V	lm	xH
E27 ECO					
4413427	1xE27	3K/4K	230V		400x290
4413527	1xE27	3K/4K	230V		500x370
LED					
4413741	8,7W	3K/4K	230V	630/650	400x290
4413742	17,5W	3K/4K	230V	1300/1350	400x290
4413751	8,7W	3K/4K	230V	630/650	500x370
4413752	17,5W	3K/4K	230V	1300/1350	500x370

Kućište: aluminij obojen termoeпокsidnom bojom
Standardna vanjska fino strukturalna boja: bijela, crna
Standardna unutarnja fino strukturalna boja: bijela
Izvor svjetla: E27 ECO i LED žarulje, LED generacije 3, self-cooling, MacAdam 3 CRI>80; LED min 50.000h L70B10 na Tp=75°C; EEI A++
Napajanje: 230V/50Hz
Električne komponente: ugrađene u kućište
Montaža: vješanjem na napojni kabel
Spajanje: putem napojnog kabela

Housing: aluminium covered with thermal epoxy colour
Standard outer finely structured color: white, black
Standard inner finely structured color: white
Light source: E27 ECO and LED bulbs, LED generation 3, self-cooling; MacAdam 3 CRI>80; LED min 50.000h L70B10 on Tp=75°C. EEI A++
Power: 230V/50Hz
Supply unit: built in the housing
Mounting: hanging on power supply cable
Connecting: through supply cable



100/80x25 mm
 ukrasna rozeta s prozirnim
 dekorativnim kabelom 6 mm
 3x0,75mm², L=1500 mm
 100/80x25 mm
 decorative box with decorative
 transparent cable 6 mm
 3x0,75 mm², L=1500 mm

prema zahtjevu
 on request:

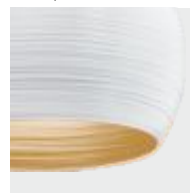

Odasijač zlatne boje
 Gold color reflector
 400 art. 681
 500 art. 682

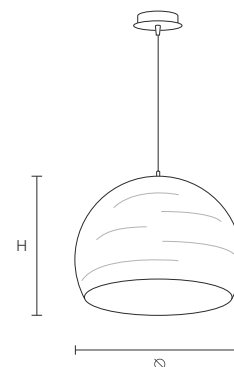

SFERA RIGGED art. 4413427

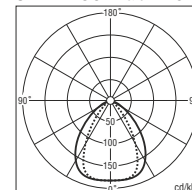

Torio

Viseća svjetiljka / *Suspended lamp*



BIJELA/WHITE (W)

CRNA/BLACK (B)

Art.	W	K	V	lm	xH
E27 ECO					
4423327	1xE27	3K/4K	230V		330x210
4423527	1xE27	3K/4K	230V		570x250
LED					
4423731	8,7W	3K/4K	230V	630/650	330x210
4423732	17,5W	3K/4K	230V	1300/1350	330x210
4423751	8,7W	3K/4K	230V	630/650	570x250
4423752	17,5W	3K/4K	230V	1300/1350	570x250

Kućište: aluminij obojen termoepoksidnom bojom
Standardna vanjska fino strukturna boja: bijela, crna
Standardna unutarnja fino strukturna boja: bijela
Izvor svjetla: E27 ECO i LED žarulje, LED generacije 3, self-cooling, MacAdam 3 CRI>80; LED min 50.000h L70B10 na Tp=75°C; EEI A++
Napajanje: 230V/50Hz
Električne komponente: ugrađene u kućište
Montaža: vješanjem na napojni kabel
Spajanje: putem napojnog kabela

Housing: aluminium covered with thermal epoxy colour
Standard outer finely structured color: white, black
Standard inner finely structured color: white
Light source: E27 ECO and LED bulbs, LED generation 3, self-cooling; MacAdam 3 CRI>80; LED min 50.000h L70B10 on Tp=75°C. EEI A++
Power: 230V/50Hz
Supply unit: built in the housing
Mounting: hanging on power supply cable
Connecting: through supply cable



100/80x25 mm
 ukrasna rozeta s prozirnim
 dekorativnim kabelom 6 mm
 3x0,75mm², L=1500 mm
 100/80x25 mm
 decorative box with decorative
 transparent cable 6 mm
 3x0,75 mm², L=1500 mm

prema zahtjevu
 on request:



Odasijač zlatne boje
 Gold color reflector
 330 art. 658
 570 art. 659

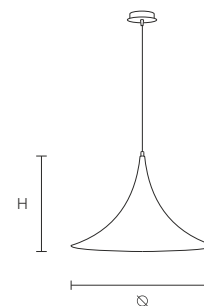

TORIO art. 4423327

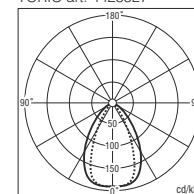

Drop

Viseća svjetiljka / *Suspended lamp*



BIJELA/WHITE (W)



CRNA/BLACK (B)

Art.	W	K	V	lm	xH
E27 ECO					
4433227	1xE27	3K/4K	230V		250x384
4433327	1xE27	3K/4K	230V		300x460
LED					
4433721	8,7W	3K/4K	230V	630/650	250x384
4433722	17,5W	3K/4K	230V	1300/1350	250x384
4433731	8,7W	3K/4K	230V	630/650	300x460
4433732	17,5W	3K/4K	230V	1300/1350	300x460

Kućište: aluminij obojen termoeпокsidnom bojom
Standardna vanjska fino strukturalna boja: bijela, crna
Standardna unutarnja fino strukturalna boja: bijela
Izvor svjetla: E27 ECO i LED žarulje, LED generacije 3, self-cooling, MacAdam 3 CRI>80; LED min 50.000h L70B10 na Tp=75°C; EEI A++
Napajanje: 230V/50Hz
Električne komponente: ugrađene u kućište
Montaža: vješanjem na napojni kabel
Spajanje: putem napojnog kabela

Housing: aluminium covered with thermal epoxy colour
Standard outer finely structured color: white, black
Standard inner finely structured color: white
Light source: E27 ECO and LED bulbs, LED generation 3, self-cooling; MacAdam 3 CRI>80; LED min 50.000h L70B10 on Tp=75°C. EEI A++
Power: 230V/50Hz
Supply unit: built in the housing
Mounting: hanging on power supply cable
Connecting: through supply cable



100/80x25 mm
 ukrasna rozeta s prozirnim
 dekorativnim kabelom 6 mm
 3x0,75mm², L=1500 mm
 100/80x25 mm
 decorative box with decorative
 transparent cable 6 mm
 3x0,75 mm², L=1500 mm

prema zahtjevu
 on request:

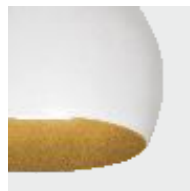

Odasijač zlatne boje
 Gold color reflector
 250 art. 656
 300 art. 657

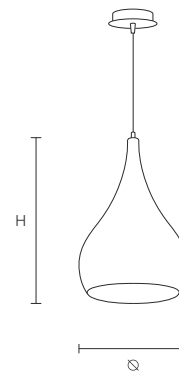

DROP art. 4433227

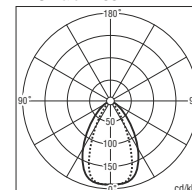

New Sun DECO

Ukrasna kupola New Sun deco je lampa dekorativnog tipa a industrijskih korijena. Odasijač od sirovog anodiziranog aluminijskog profila spojen je sa ukrasnim rebrastim profilom te zajedno stvaraju impozantnu i prekrasnu cijelinu. Lampa dolazi u standardnoj E27 te LED varijanti a svjetlost pri reflektiranju od odasijača stvara ugodnu i toplu atmosferu.

Ornamental dome New Sun deco is a decorative luminaire of industrial heritage.

Reflector made from raw anodized aluminium profile is paired with anodized aluminium decorative ribs, which together create an impressive and beautiful product.

Luminaire comes in standard E27 and LED variant and the lighting emitted from the reflector creates cosy and warm atmosphere.

NAMJENA / USAGE



New sun deco

Viseći industrijski reflektor / *Suspended industrial reflector*

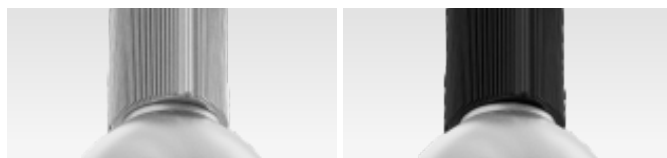

ALUMINIJ/ALUMINIUM (A)

CRNA/BLACK (B)

Art.	W	K	V	lm	x H	kg
E27 ECO						
4513027	1xE27	3K/4K	230V		360x480	5,4
LED						
4513717	17,6W	3K/4K	500mA	2593/2673	360x480	5,4
4513726	25,5W	3K/4K	700mA	3499/3606	360x480	5,4
4513732	24,7W	3K/4K	700mA	4010/4134	360x480	5,4
4513734	35,2W	3K/4K	700mA	5518/5689	360x480	5,4

Kućište: ekstrudirani anodizirani aluminijski profil s ukrasnim rebrima za odvodnju temperature

Standardna boja: anodizirani aluminij, crna

Električne komponente: ugrađene u kućište

Izvor svjetla: E27 ECO, LED Multichip najnovije generacije koji omogućuju visoku efikasnost i učinkovitost CRI>80; životni vijek LED izvora min 70.000h L70B10 na Tp=75°C; EEI A++

Odasiyač: iz 99,85% aluminija, oksidiranog i anodiziranog

Montaža: pomoću visilica s auto blok sustavom, max L=1500mm (u kompletu)

Spajanje: skidanjem rozete dostupne su priključne stezaljke i ostale električne komponente

Prema zahtjevu: regulacijska jedinica DALI, DIM (pogledati upute za naručivanje; str. 180)

Housing: Extruded anodized aluminum profile with decorative ribs for temperature dissipation

Standard color: anodized aluminium

Supply unit: built in the housing

Light source: E27 ECO, Multichip LED latest generation with high efficiency and effectivity CRI>80. Lifetime of LED's 70.000h L70B10 on Tp=75°C. EEI class A++

Reflector: of 99,85% aluminium, oxidated and anodized

Mounting: hanging on steel suspension with auto block system, max L=1500mm (set included)

Connecting: through removing the decorative box, connection clamps and all other electronic components are available

On request: regulation unit DALI, DIM (see ordering instructions; pg. 180)



Prema zahtjevu:
On request:



Zaštitno staklo IP55
Protective glass IP55
art. 605

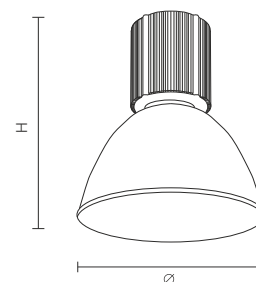

NEW SUN art. 4513732

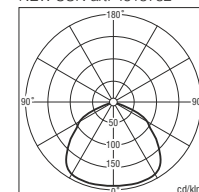

Icon

Svjetiljka iz aluminija minimalističkog dizajna, elegantnih i modernih linija. Pogodne za montažu u stambenim, poslovnim, hotelskim prostorima, idealne za naglašavanje arhitektonskih značajki unutrašnjih prostora te svojom uskom distribucijom svjetlosnog snopa usmjeruju pažnju na najznačajnije karakteristike te daju puninu i voluminoznost. Aluminijsko tijelo svjetiljke omogućuje visoku trajnost i kvalitetu proizvoda a izbor finostrukturnih boja omogućuje uklapanje u svaki interijer.

Minimalistic aluminium luminaire with elegant and modern design. Suitable for use in housing, offices and tourism, ideal for accentuating architectural features of interior spaces and to focus attention with its narrow beam light emission, thus giving richness and voluminosity. Aluminium body of the luminaire offers high durability and quality of the product and the finely-structured color selection enables integration into any interior space.

NAMJENA / USAGE





PROJECT: Kozlović Winery
PHOTOGRAPHER: Eltor

Icon

Nadgradna svjetiljka / Surface lamp



BIJELA/WHITE (W)

SIVA/GREY(G)

CRNA/BLACK (B)

Art.	W	K	V	lm	x H	kg
GU10						
4251050	1 x GU10	3K/4K	230V		100x500	1,0
4251080	1 x GU10	3K/4K	230V		100x800	1,3
LED						
4251711	10,7W	3K/4K	230V	1100/1200	100x500	1,0
4251712	10,7W	3K/4K	230V	1100/1200	100x800	1,3
4251721	12,8W	3K/4K	230V	1340/1460	100x500	1,0
4251722	12,8W	3K/4K	230V	1340/1460	100x800	1,3

Kućište: ekstrudirani aluminij obojan termoeпокsidnom bojom

Standardna finostrukturna boja: bijela, siva, crna

Napajanje: 230V/50Hz

Električne komponente: ugrađene u kućište

Izvor svjetla: GU10 žarulje, LED najnovije generacije, MacAdam 4 CRI>80; LED min 50.000h L80F50 na Tp=75°C; EEL A

Difuzor: protubješteći opalni polikarbonat homogenog efekta tehnologije "Crystal Ice"

Montaža: pomoću vijaka na strop

Spajanje: demontažom gornjeg poklopca (nosača) dostupne su priključne stezaljke i ostale električne komponente

Prema zahtjevu: regulacijska jedinica DALI, DIM (vidi upute za naručivanje str. 180)

Housing: extruded aluminium covered with thermal epoxy colour

Standard finely-textured color: white, gray, black

Power: 230V/50Hz

Supply unit: built in the housing

Light source: GU10 bulbs, LED newest generation, MacAdam 4 CRI>80; LED min 50.000h L80F50 on Tp=75°C. EEL A

Diffuser: anti-glare opal polycarbonate with homogenous effect with "Crystal Ice" technology

Mounting: with screws to the ceiling

Connecting: through disassembling upper cover (bracket), connection clamps and other electronic components are available

On request: regulation unit DALI, DIM (see ordering instructions on pg. 180)



Prema zahtjevu:
On request:

prema zahtjevu / on request:

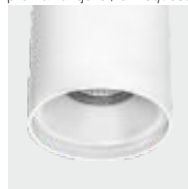

Odasijač u boji svjetiljke IP20
Reflector in luminaire color IP20
art. 693



Odasijač zlatne boje IP20
Gold color reflector IP20
art. 692

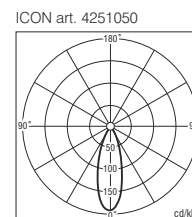
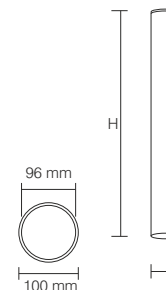

Icon suspended

Viseća svjetiljka / *Suspended lamp*

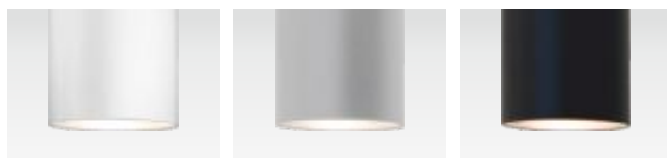

BIJELA/WHITE (W)

SIVA/GREY (G)

CRNA/BLACK (B)

Art.	W	K	V	lm	x H	kg
GU10						
4253050	1 x GU10	3K/4K	230V		100x500	1,0
4253080	1 x GU10	3K/4K	230V		100x800	1,3
LED						
4253711	10,7W	3K/4K	230V	1100/1200	100x500	1,0
4253712	10,7W	3K/4K	230V	1100/1200	100x800	1,3
4253721	12,8W	3K/4K	230V	1340/1460	100x500	1,0
4253722	12,8W	3K/4K	230V	1340/1460	100x800	1,3

Kućište: ekstrudirani aluminij obojan termoepoksidnom bojom

Standardna finostrukturna boja: bijela, siva, crna

Napajanje: 230V/50Hz

Električne komponente: ugrađene u kućište

Izvor svjetla: GU10 žarulje, LED najnovije generacije, MacAdam 4 CRI>80; LED min 50.000h L80F50 na Tp=75°C; EEI A

Difuzor: protubješteći opalni polikarbonat homogenog efekta tehnologije "Crystal Ice"

Montaža: vješanjem na napojni kabel

Spajanje: skidanjem ukrasne rozete dostupne su priključne stezaljke i ostale električne komponente

Housing: extruded aluminium covered with thermal epoxy colour

Standard finely-textured color: white, gray, black

Power: 230V/50Hz

Supply unit: built in the housing

Light source: GU10 bulbs, LED newest generation, MacAdam 4 CRI>80;

LED min 50.000h L80F50 on Tp=75°C. EEI A

Diffuser: anti-glare opal polycarbonate with homogenous effect with "Crystal Ice" technology

Mounting: hanging on power supply cable

Connecting: through removing the decorative box, connection clamps and all other electronic components are available



100/80x25 mm
ukrasna rozeta s prozirnim
dekorativnim kabelom 6 mm
3x0,75mm², L=1500 mm

100/80x25 mm
decorative box with decorative
transparent cable 6 mm
3x0,75 mm², L=1500 mm

prema zahtjevu / on request:

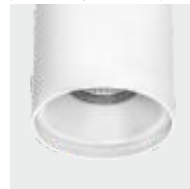

Odasijač u boji svjetiljke
Reflector in luminaire color
art. 693



Odasijač zlatne boje
Gold color reflector
art. 692

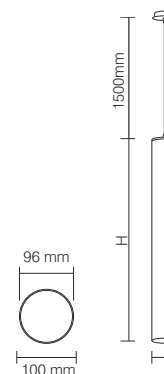

ICON art. 4253050

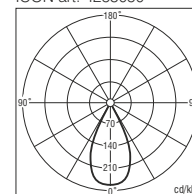

Icon slim

Viseća svjetiljka / *Suspended lamp*

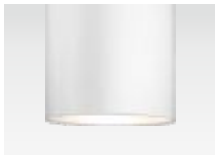

BIJELA/WHITE (W)

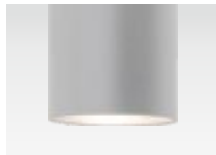

SIVA/GREY(G)

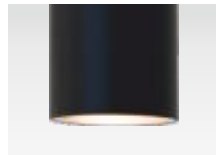

CRNA/BLACK (B)

Art.	W	K	V	lm	x H	kg
GU10						
4393050	1 x GU10	3K/4K	230V		55x500	1,0
4393080	1 x GU10	3K/4K	230V		55x800	1,3
LED						
4393711	10,7W	3K/4K	230V	1100/1200	55x500	1,0
4393712	10,7W	3K/4K	230V	1100/1200	55x800	1,3
4393721	12,8W	3K/4K	230V	1340/1460	55x500	1,0
4393722	12,8W	3K/4K	230V	1340/1460	55x800	1,3

Kućište: ekstrudirani aluminij obojan termoeпокsidnom bojom
Standardna finostrukturna boja: bijela, siva, crna
Napajanje: 230V/50Hz
Električne komponente: ugrađene u kućište
Izvor svjetla: GU10 žarulje, LED najnovije generacije, MacAdam 4 CRI>80; LED min 50.000h L80F50 na Tp=75°C; EEI A
Montaža: vješanjem na napojni kabel
Spajanje: skidanjem ukrasne rozete dostupne su priključne stezaljke i ostale električne komponente

Housing: extruded aluminium covered with thermal epoxy colour

Standard finely-textured color: white, gray, black

Power: 230V/50Hz

Supply unit: built in the housing

Light source: GU10 bulbs, LED newest generation, MacAdam 4 CRI>80;

LED min 50.000h L80F50 on Tp=75°C. EEI A

Mounting: hanging on power supply cable

Connecting: through removing the decorative box, connection clamps and all other electronic components are available



100/80x25 mm
ukrasna rozeta s prozirnim
dekorativnim kabelom 6 mm
3x0,75mm², L=1500 mm

100/80x25 mm
decorative box with decorative
transparent cable 6 mm
3x0,75 mm², L=1500 mm

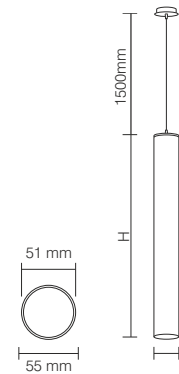

ICON art. 4253050

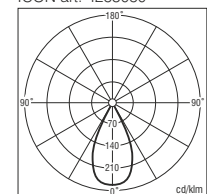

Icon single

Viseća svjetiljka / *Suspended lamp*



BIJELAWHITE (W)



SIVA/GREY (G)



CRNA/BLACK (B)

Art.	W	K	V	lm	xH	kg
DULUX T/E						
4343242	1x42W	3K/4K	230V		150x325	3,8
HCI-T						
4343270	1x70W	3K/4K	230V		150x325	3,8
4343215	1x150W	3K/4K	230V		150x325	3,8
PAR30						
4343275	1x75W	3K/4K	230V		150x325	3,8
LED						
4343711	17,6W	3K/4K	500mA	2593/2673	150x325	3,8
4343712	25,5W	3K/4K	700mA	3499/3606	150x325	3,8

Kućište: ekstrudirani aluminij obojan termoepoksidnom bojom

Standardna finostrukturna boja: bijela, siva, crna

Napajanje: 230V/50Hz

Električne komponente: ugrađene u kućište

Izvor svjetla: Dulux T/E žarulje, halogene žarulje PAR30 max. 75W, metal halogene žarulje, max. 150W

Difuzor: kaljeno staklo visoke čvrstoće Clear Vision

Montaža: pomoću visilice s autoblokirnim sistemom (u kompletu)

Spajanje: sa ukrasnom rozetom s prozirnim dekorativnim kabelom 3x0,75 mm L=1500 mm

Housing: extruded aluminium covered with thermal epoxy colour

Standard finely-textured color: white, grey, black

Power: 230V/50Hz

Supply unit: built in the housing

Light source: Dulux T/E bulb, halogen bulbs PAR30 max 75W, metal halogen bulbs, max. 150W

Diffuser: tempered, high resistance Clear Vision glass

Mounting: hanging on steel suspension with auto block system, max

L=1500mm (set included)

Connecting: through decorative box with decorative transparent cable 3x0,75 mm L=1500 mm

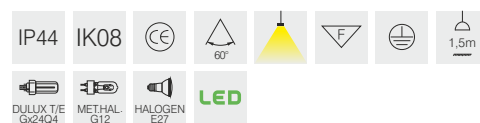

125/100x25 mm
ukrasna rozeta s prozirnim
dekorativnim kabelom 6 mm
1x0,75mm², L=1500 mm

125/100x25 mm
decorative box with decorative
transparent cable 6 mm
1x0,75 mm², L=1500 mm



Dekorativna sajla za
vješanje L=1500mm

Decorative hanging
wire l=1500mm

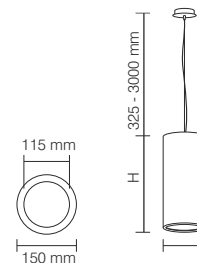

ICON SINGLE art. 4343242

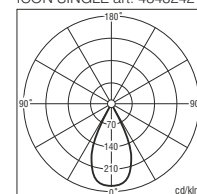

Icon double

Dvostruka viseća svjetiljka / Double suspended lamp



BIJELA/WHITE (W)



SIVA/GREY (G)



CRNA/BLACK (B)

Kućište: ekstrudirani aluminij obojan termoeпокsidnom bojom
Standardna finostrukturna boja: bijela, siva, crna
Napajanje: 230V/50Hz
Električne komponente: ugrađene u kućište
Izvor svjetla: Dulux T/E žarulje, halogene žarulje PAR30 max. 75W, metal halogene žarulje, max. 150W
Difuzor: kaljeno staklo visoke čvrstoće Clear Vision
Montaža: pomoću visilica s autoblokirnim sistemom (u kompletu)
Spajanje: sa ukrasnom rozetom s prozirnim dekorativnim kabelom 3x0,75 mm L=1500 mm

Housing: extruded aluminium covered with thermal epoxy colour
Standard finely-textured color: white, gray, black
Power: 230V/50Hz
Supply unit: built in the housing
Light source: Dulux T/E bulbs, halogen lamps PAR30 max 75W, metal halogen bulbs, max. 150W
Diffuser: tempered, high resistance Clear Vision glass
Mounting: hanging on steel suspension with auto block system, max L=1500mm (set included)
Connecting: through decorative box with decorative transparent cable 3x0,75 mm L=1500 mm

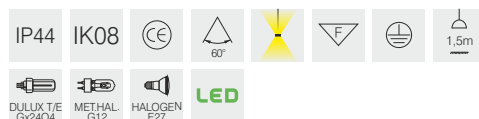

Art.	W	K	V	lm	xH	kg
DULUX T/E						
4353242	2x42W	3K/4K	230V		150x650	7,6
HCI-T						
4353270	2x70W	3K/4K	230V		150x650	7,5
4353215	2x150W	3K/4K	230V		150x650	7,7
PAR30						
4353275	2x75W	3K/4K	230V		150x650	7,7
LED						
4353711	17,6W	3K/4K	500mA	2593/2673	150x650	7,7
4353712	25,5W	3K/4K	700mA	3499/3606	150x650	7,7



125/100x25 mm
 ukrasna rozeta s prozirnim
 dekorativnim kabelom 6 mm
 1x0,75mm², L=1500 mm
 125/100x25 mm
 decorative box with decorative
 transparent cable 6 mm
 1x0,75 mm², L=1500 mm



Dekoratívna saja za
 vješanje x3, L=1500mm
 Decorative hanging
 wire x3, l=1500mm

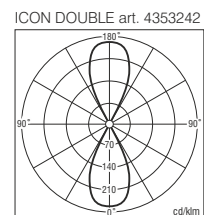
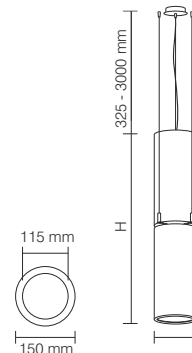

Icon 200

Nadgradna svjetiljka / Surface lamp



BIJELAWHITE (W)

SIVA/GREY (G)

CRNA/BLACK (B)

Art.	W	K	V	lm	x H	kg
GU10						
4261050	1 x GU10	3K/4K	230V		100x200	0,6
LED						
4261710	10,7W	3K/4K	230V	1100/1200	100x200	0,7
4261711	12,8W	3K/4K	230V	1340/1460	100x200	0,7

Kućište: ekstrudirani aluminij obojan termoepoksidnom bojom

Standardna finostrukturna boja: bijela, siva, crna

Napajanje: 230V/50Hz

Električne komponente: ugrađene u kućište

Izvor svjetla: GU10 žarulje, LED najnovije generacije, MacAdam 4 CRI>80; LED min 50.000h L80F50 na Tp=75°C; EEI A

Montaža: vijcima na strop

Spajanje: demontažom gornjeg poklopca (nosača), dostupne su priključne stezaljke i ostale električne komponente

Housing: extruded aluminium covered with thermal epoxy colour

Standard finely-textured color: white, gray, black

Power: 230V/50Hz

Supply unit: built in the housing

Light source: GU10 bulbs, LED newest generation, MacAdam 4 CRI>80; LED min 50.000h L80F50 on Tp=75°C. EEI A

Mounting: with screws to the ceiling

Connecting: through disassembling upper cover (bracket), connection clamps and all other electronic components are available



Prema zahtjevu:
On request:



prema zahtjevu / on request:



Odasijač zlatne boje
Gold color reflector
art. 692

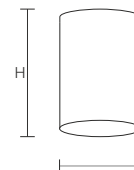

ICON 150 art. 4261049

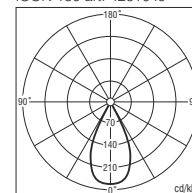

Icon wall

Zidna svjetiljka / Wall lamp



Kućište: ekstrudirani aluminij obojan termoeпокsidnom bojom
Standardna finostrukturna boja: bijela, siva, crna
Napajanje: 230V/50Hz
Električne komponente: ugrađene u kućište
Izvor svjetla: halogene GU10 žarulje
Montaža: nosačem na zid
Spajanje: demontažom nosača dostupne su priključne stezaljke i ostale električne komponente

Housing: extruded aluminium covered with thermal epoxy colour
Standard color: white, gray, black
Power: 230V/50Hz
Supply unit: built in the housing
Light source: Halogen GU10 bulbs
Mounting: with bracket to the wall
Connecting: through disassembling the bracket, connection clamps and all other electronic components are available



Art.	W	K	V	lm	x H	kg
DIRECT GU10						
4264050	1 x GU10	3K/4K	230V		100x110	0,5
DIRECT/INDIRECT GU10						
4264250	2 x GU10	3K/4K	230V		100x220	1,1

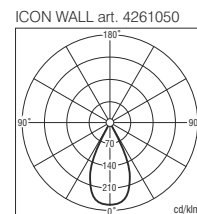
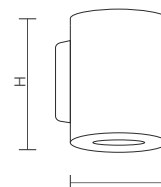



PROJECT: Kozlović Winery
PHOTOGRAPHER: Eltor

Icon table

Stolna svjetiljka / Table lamp



BIJELA/WHITE (W)



CRVENA/RED (G)



CRNA/BLACK (B)

Kućište: aluminij obojan termoepoksidnom bojom

Standardna boja: bijela, crna, crvena

Boja napojnog kabela: crvena, crna, crno-bijela

Napajanje: 230V/50Hz

Izvor svjetla: E14 žarulje

Montaža: samostojeća stolna svjetiljka

Prema zahtjevu: napojni kabel u raznim bojama

Housing: aluminium, covered with thermal epoxy color

Standard color: white, black, red

Power cord color: transparent, black/white, red, black

Power: 230V/50Hz

Light source: E14 bulbs

Mounting: freestanding lamp

On request: power cord in different colors



Art.	W	V	xH	kg
E14 ECO				
4278140	1 x E14	230V	100x380	0,3

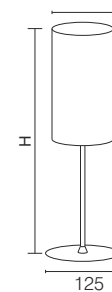





Plat

Dizajn svjetiljke PLAT inspiriran je geometrijskim i oku ugodnim oblicima.

Kućište od ekstrudiranog aluminijskog profila je istovremeno elegantno i čvrsto a difuzor izrađen od opalnog polikarbonata omekšava svjetlosni snop.

Minimalistički i nenametljiv dizajn savršen je za uklapanje u moderno dizajnirane interijere, trgovine, stambene prostore i hotelijerske komplekse.

The design of PLAT luminaire is inspired with simple geometric and eye pleasing shapes.

Housing made from extruded aluminium profile is at the same time elegant and sturdy and the diffuser is made from opal polycarbonate that softens the light beam.

With a minimalistic and unobtrusive design it fits perfectly in modern interiors, shops, living spaces and hotel complexes.

NAMJENA / USAGE





PROJECT: Villa Radetići
DESIGNER: BR homes
PHOTO: Level 52

Plat

Nadgradna LED svjetiljka / Surface mounted LED lamp



BIJELA/WHITE (W)



SIVA/GREY (G)



CRNA/BLACK (B)

Art.	W	K	V	lm	xH
LED					
3431706	7,5W	3K/4K	230V	930/1020	130x130
3431708	14,9W	3K/4K	230V	1860/2040	130x130
3431710	17,5W	3K/4K	230V	1500/1590	130x130

Kućište: ekstrudirani aluminij obojan termoeпокsidnom bojom

Standardna finostrukturna boja: bijela, siva, crna

Napajanje: 230V/50Hz

Električne komponente: ugrađene u kućište

Izvor svjetla: LED generacije 3, self-cooling, MacAdam 3 CRI>80; LED min 60.000h L80F50 na $T_p=65^{\circ}\text{C}$; EEL A++

Difuzor: protubljesteći opalni polikarbonat homogenog efekta tehnologije "Crystal Ice"

Montaža: vijcima na strop/zid

Spajanje: skidanjem kućišta dostupne su priključne stezaljke i ostale električne komponente

Prema zahtjevu: regulacijska jedinica DALI, DIM (vidi upute za naručivanje str. 180)

Housing: extruded aluminium covered with thermal epoxy colour

Standard finely-textured color: white, grey, black

Power: 230V/50Hz

Supply unit: built in the housing

Light source: LED generation 3, self-cooling; MacAdam 3 CRI>80; LED min 60.000h L80F50 on $T_p=65^{\circ}\text{C}$. EEL A++

Diffuser: anti-glare opal diffuser with homogenous effect "Crystal Ice"

Mounting: with screws to the ceiling/wall

Connecting: through removing the housing, connection clamps and all other electronic components are available

On request: regulation unit DALI, DIM (see ordering instructions on pg. 180)



Prema zahtjevu: DALI, DIM

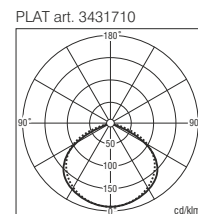
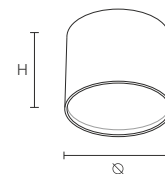





Style

Svjetiljka jednostavnog kvadratnog oblika dostupna u raznim varijantama, idealna je za naglašavanje arhitektonskih karakteristika prostora sa širokom paletom izvedbi. Dostupna je u nadgradnoj, zidnoj i visećoj varijanti. Zbog svog jednostavnog dizajna i oštih linija lako će se uklopiti u svaki prostor te ga istovremeno estetski podignuti na višu razinu.

Square luminaire ideal for accentuating space with wide variety of types. It comes in ceiling, wall mounted and suspended variation.

The minimalistic design elements and straight lines it fits easily in any space while at the same time enhancing the space aesthetically on a new level.

NAMJENA / USAGE



Style

Nadgradna/zidna svjetiljka / Surface/wall mounted lamp



BIJELA/WHITE (W)

SIVA/GREY (G)

CRNA/BLACK (B)

Art.	W	K	V	AxBxH	kg
GU10 Nadgradni/Ceiling					
4041150	1 x GU10	3K/4K	230V	100x100x110	0,8

Art.	W	K	V	AxBxH	kg
GU10 Zidni/Wall					
4044150	1 x GU10	3K/4K	230V	100x100x110	1,0

Kućište: ekstrudirani aluminij obojan termoepoksidnom bojom
Standardna fino strukturna boja: bijela, siva, crna
Napajanje: 230V/50Hz
Električne komponente: ugrađene u kućište
Izvor svjetla: GU10 žarulje
Montaža: pomoću vijaka na strop/zid
Spajanje: skidanjem kućišta dostupne su priključne stezaljke i ostale električne komponente

Housing: extruded aluminium covered with thermal epoxy colour

Standard finely-textured color: white, gray, black

Power: 230V/50Hz

Supply unit: built in the housing

Light source: GU10 bulbs

Mounting: with screws to the ceiling/wall

Connecting: through removing the housing, connection clamps and all other electronic components are available

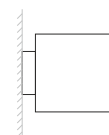
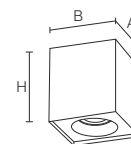

STYLE art. 4041701

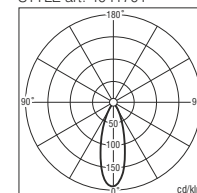



PROJECT: Italian community building
PHOTOGRAPHER: Eltor

Style double

Nadgradna/zidna svjetiljka / Surface/wall mounted lamp



BIJELA/WHITE (W)



SIVA/GREY (G)



CRNA/BLACK (B)

Kućište: ekstrudirani aluminij obojan termoepoksidnom bojom
Standardna fino strukturna boja: bijela, siva, crna
Napajanje: 230V/50Hz
Električne komponente: ugrađene u kućište
Izvor svjetla: GU10 žarulje
Montaža: pomoću vijaka na strop/zid
Spajanje: skidanjem kućišta dostupne su priključne stezaljke i ostale električne komponente

Housing: extruded aluminium covered with thermal epoxy colour

Standard finely-textured color: white, gray, black

Power: 230V/50Hz

Supply unit: built in the housing

Light source: GU10 bulbs

Mounting: with screws to the ceiling/wall

Connecting: through removing the housing, connection clamps and all other electronic components are available



Art.	W	K	V	AxBxH	kg
GU10 Nadgradni/Ceiling					
4041250	2 x GU10	3K/4K	230V	200x100x110	1,50

Art.	W	K	V	AxBxH	kg
GU10 Zidni/Wall					
4044250	2 x GU10	3K/4K	230V	200x100x110	1,70

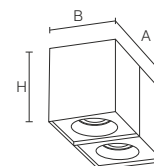
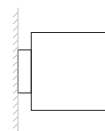
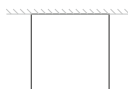

STYLE art. 4041701

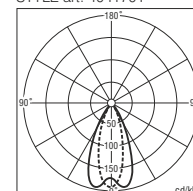

Style suspended

Viseća svjetiljka / Suspended lamp



BIJELA/WHITE (W)



SIVA/GREY (G)



CRNA/BLACK (B)

Art.	W	K	V	AxBxH	kg
GU10					
4043150	1 x GU10	3K/4K	230V	100x100x110	0,7
4043250	1 x GU10	3K/4K	230V	100x100x220	1,5

Kućište: ekstrudirani aluminij obojan termoeпокsidnom bojom
Standardna fino strukturna boja: bijela, siva, crna
Napajanje: 230V/50Hz
Električne komponente: ugrađene u kućište
Izvor svjetla: GU10 žarulje
Montaža: vješanjem na napojni kabel, max. L=1500mm
Spajanje: skidanjem ukrasne rozete dostupne su priključne stezaljke i ostale električne komponente

Housing: extruded aluminium covered with thermal epoxy colour

Standard finely-textured color: white, gray, black

Power: 230V/50Hz

Supply unit: built in the housing

Light source: GU10 bulbs

Mounting: hanging on power supply cable, max. L=1500mm

Connecting: through removing the decorative rozeta dostupne su priključne stezaljke i ostale električne komponente are available



90x90x25 mm
 ukrasna rozeta s prozirnim
 dekorativnim kabelom 6 mm
 3x0,75mm², L=1500 mm
 90x90x25 mm
 decorative box with decorative
 transparent cable 6 mm
 3x0,75 mm², L=1500 mm

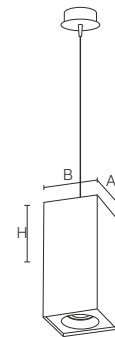

STYLE art. 4043150

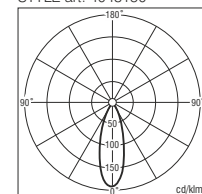

Style D/I

Zidna svjetiljka / Wall mounted lamp

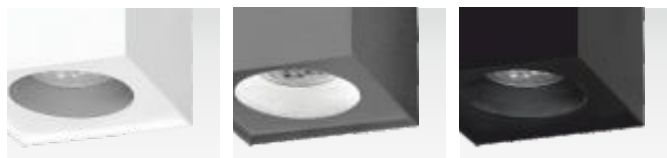

BIJELA/WHITE (W)

SIVA/GREY (G)

CRNA/BLACK (B)

Art.	W	K	V	AxBxH	kg
GU10					
4044251	2 x GU10	3K/4K	230V	100x100x220	1,5

Kućište: ekstrudirani aluminij obojan termoepoksidnom bojom

Standardna fino strukturna boja: bijela, siva, crna

Napajanje: 230V/50Hz

Električne komponente: ugrađene u kućište

Izvor svjetla: GU10 žarulje

Montaža: pomoću vijaka na strop/zid

Spajanje: skidanjem kućišta dostupne su priključne stezaljke i ostale električne komponente

Housing: extruded aluminium covered with thermal epoxy colour

Standard finely-textured color: white, gray, black

Power: 230V/50Hz

Supply unit: built in the housing

Light source: GU10 bulbs

Mounting: with screws to the ceiling/wall

Connecting: through removing the housing, connection clamps and all other electronic components are available

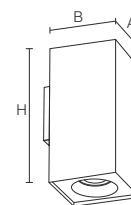

STYLE art. 4044703

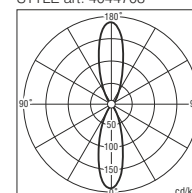

Aura

Dekoratívne stropne svjetiljke linija Aura nastaju iz ručno puhanog troslojnog "triplex opal" Murano stakla kako bi se postigla visoka trajnost i kvaliteta difuzora te homogeni efekt svjetlosti, koji omogućuje visok stupanj komfora i oku ugodno osvjetljenje a zaobljeni oblik stakla uklapa se u prostore boravka, pružajući nježne i fluidne linije, te estetski oplemenjuje prostor i podiže ga na višu razinu.

Decorative ceiling Aura line of luminaires are created from hand blown three-layer "triplex opal" Murano glass. This way the high durability and diffuser quality is achieved, along with homogenous effect which creates a high-comfort atmosphere and eye pleasing illumination. Curved shape of glass fits perfectly in all living areas and at the same time elevates the space on the next level.

NAMJENA / USAGE



Aura

Nadgradna stropna/zidna LED svjetiljka / Surface ceiling/wall mounted LED lamp

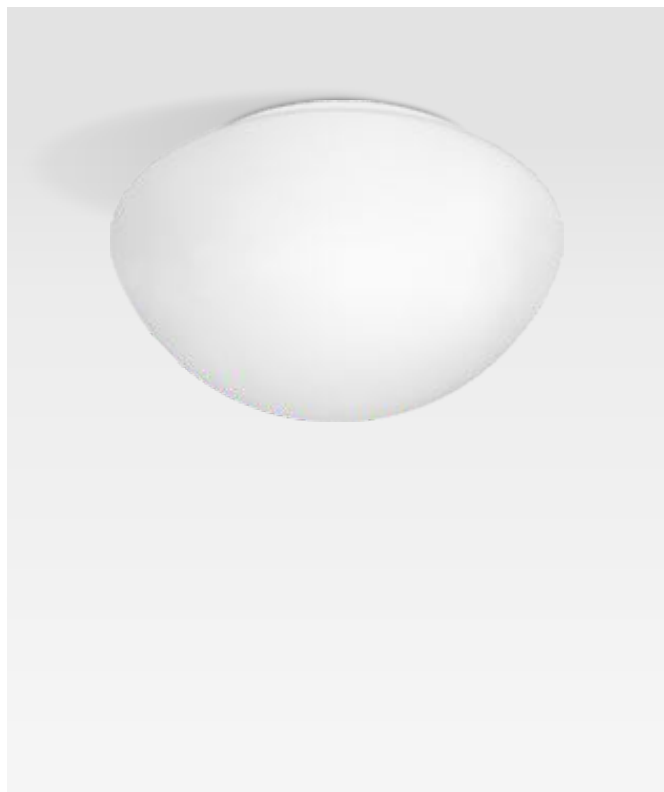

Kućište: čelični lim obojan termoeпокsidnom finostrukturnom bijelom bojom

Napajanje: 230V/50Hz

Električne komponente: ugrađene u kućište

Izvor svjetla: Dulux D/E, T/E, E27 ECO žarulje, LED generacije 3, self-cooling, MacAdam 3 CRI>80; LED min 60.000h L80F50 na $T_p=65^{\circ}\text{C}$; EEI A++

Difuzor: protublješteće opalno satinirano troslojno triplex Murano staklo homogenog efekta

Montaža: pomoću vijaka na strop/zid

Spajanje: skidanjem difuzora (klik sustav) dostupne su priključne stezaljke i ostale električne komponente

Housing: steel sheet-metal covered with thermal epoxy finely-textured white colour

Power: 230V/50Hz

Supply unit: built in the housing

Light source: Dulux D/E, T/E, E27 ECO bulbs, LED generation 3, self-cooling; MacAdam 3 CRI>80; LED min 60.000h L80F50 on $T_p=65^{\circ}\text{C}$. EEI A++

Diffuser: glare-free opal satinated three-layer triplex Murano glass with homogenous effect

Mounting: with screws to the ceiling/wall

Connecting: through removing the diffuser (with click system), connection clamps and all other electronic components are available

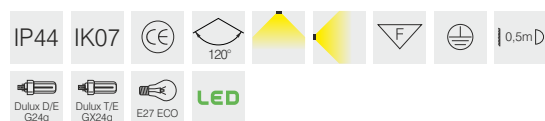

Art.	W	K	V	lm	xH	kg
E27 ECO						
4181060	1 x E27	3K/4K	230V		220x110	0,9
4181100	1 x E27	3K/4K	230V		280x120	1,1
4181260	2 x E27	3K/4K	230V		350x120	1,6
4181275	2 x E27	3K/4K	230V		420x120	4,0
4181360	3 x E27	3K/4K	230V		490x120	4,4
TC-D/E						
4181113	1x13W	3K/4K	230V		220x110	1,2
4181118	1x18W	3K/4K	230V		280x120	1,5
4181218	2x18W	3K/4K	230V		350x120	2,3
4181226	2x26W	3K/4K	230V		420x120	5,0
TC-T/E						
4181232	2x32W	3K/4K	230V		490x120	4,7
LED						
4181711	15,3W	3K/4K	230V	2070/2250	220x110	0,9
4181721	23,1W	3K/4K	230V	2830/3100	280x120	1,1
4181731	18,3W	3K/4K	230V	2600/2840	350x120	1,6
4181741	29,2W	3K/4K	230V	3750/4090	420x120	4,0
4181751	35,0W	3K/4K	230V	4798/5036	490x120	4,4

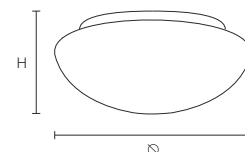

Slični proizvodi
Related products:



CIRCOLINA
Str. 58

AURA art. 4181060

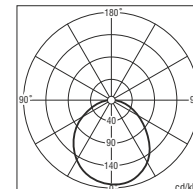

Aura AP

Nadgradna LED zidna svjetiljka / Wall mounted LED lamp



Kućište: čelični lim obojan termoeпокsidnom finostrukturnom bijelom bojom

Napajanje: 230V/50Hz

Električne komponente: ugrađene u kućište

Izvor svjetla: Dulux D/E i T/E žarulje, E27 ECO

Difuzor: protublješteće opalno satinirano troslojno triplex Murano staklo homogenog efekta

Montaža: pomoću vijaka na zid

Spajanje: skidanjem difuzora dostupne su priključne stezaljke i ostale električne komponente

Housing: steel sheet-metal covered with thermal epoxy finely-textured white colour

Power: 230V/50Hz

Supply unit: built in the housing

Light source: Dulux D/E and T/E bulbs, E27 ECO

Diffuser: glare-free opal satinated three-layer triplex Murano glass with homogenous effect

Mounting: with screws to the wall

Connecting: through removing the diffuser, connection clamps and all other electronic components are available



Art.	W	K	V	A x B x H	kg
E27 ECO					
4184060	1 x E27	3K/4K	230V	250x140x120	1,6
4184100	1 x E27	3K/4K	230V	350x150x190	2,0
4184260	2 x E27	3K/4K	230V	350x200x175	2,4
TC-D/E					
4184113	1x13W	3K/4K	230V	250x140x120	1,8
4184126	1x26W	3K/4K	230V	350x150x190	2,4
TC-T/E					
4184232	1x42W	3K/4K	230V	350x200x175	2,6

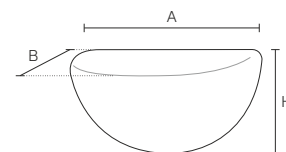

Slični proizvodi
Related products:



GREEK
Str. 54

AURA AP art. 4184060

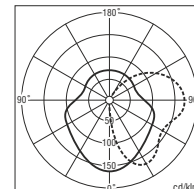



Greek

Minimalistička, dekorativna zidna lampa polu-kružnog oblika. Greek je izrađen od 100% prirodnog gipsanog kalcijevog **alabastera**, nastalog mješanjem mineralnih spojeva. Lampa dolazi u standardnoj i direkt/indirektnoj varijanti te je idealna za dekoraciju stambenih prostora, hodnika i ureda.

*Minimalistic, decorative semi circular luminaire for wall mounting. Greek is made from 100% natural gypsum calcite **alabaster**, created by mixing mineral elements. Luminaire comes in standard and direct/indirect variant and it's ideal for decorative use in living spaces, halls and offices.*

NAMJENA / USAGE



Greek

Zidna Alabaster svjetiljka / Wall mounted Alabaster lamp



Kućište: gipsani kalcijev alabaster

Standardna boja: bijela

Napajanje: 230V/50Hz

Električne komponente: ugrađene u kućište

Izvor svjetla: LED najnovije generacije, MacAdam 3 CRI>80; LED min 50.000h $T_p=75^{\circ}\text{C}$; EEI A

Montaža: pomoću vijaka na zid

Spajanje: skidanjem kućišta dostupne su priključne stezaljke i ostale električne komponente

Housing: gypsum calcite alabaster

Standard color: white

Power: 230V/50Hz

Supply unit: built in the housing

Light source: LED newest generation, MacAdam 3 CRI>80; LED min 50.000h $T_p=75^{\circ}\text{C}$. EEI A

Mounting: with screws to the wall

Connecting: through removing the housing, connection clamps and all other electronic components are available



Art.	W	K	V	lm	A x B x H	kg
LED						
3524721	11,3W	3K/4K	230V	1100/1100	280x140x150	0,6
3524722	17,5W	3K/4K	230V	1300/1400	280x140x150	0,6

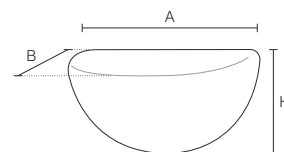

Slični proizvodi
Related products:



AURA AP
Str. 51

GREEK art. 3524721

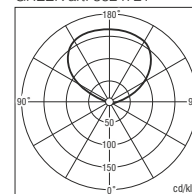

Greek D/I

Zidna direkt/indirekt Alabaster svjetiljka / Wall mounted direct/indirect Alabaster lamp



Kućište: gipsani kalcijev alabaster

Standardna boja: bijela

Napajanje: 230V/50Hz

Električne komponente: ugrađene u kućište

Izvor svjetla: LED najnovije generacije, MacAdam 3 CRI>80; LED min 50.000h Tp=75°C; EEI A

Montaža: pomoću vijaka na zid

Spajanje: skidanjem kućišta dostupne su priključne stezaljke i ostale električne komponente

Housing: gypsum calcite alabaster

Standard color: white

Power: 230V/50Hz

Supply unit: built in the housing

Light source: LED newest generation, MacAdam 3 CRI>80; LED min 50.000h Tp=75°C. EEI A

Mounting: with screws to the wall

Connecting: through removing the housing, connection clamps and all other electronic components are available



Art.	W	K	V	lm	A x B x H	kg
LED						
3534721	11,3W	3K/4K	230V	1100/1100	280x140x150	0,5
3534722	17,5W	3K/4K	230V	1300/1400	280x140x150	0,5

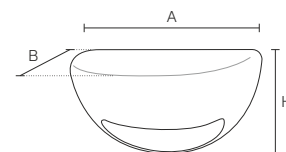

GREEK art. 3534721

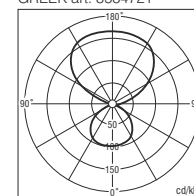



Circolina

Dekorativna svjetiljka iz samogasivog polikarbonata
Dolazi u stropnoj kružnoj izvedbi a zahvaljujući homogenom efektu opalnog polikarbonata, svjetlost je mekana, oku ugodna i opuštajuća.
Circolina svjetiljke svojim su dizajnom idealne za kreativnu dekoraciju prostora.

*Decorative luminaire made from self-extinguishing polycarbonate.
It comes in circular design for ceilings and thanks to the homogenic effect of opal polycarbonate, the light is mellow, eye pleasing and relaxing.
Circolina luminaire is ideal for creative decoration of space.*

NAMJENA / USAGE



Circolina

Nadgradna svjetiljka / Surface mounted lamp



Kućište: samogasivi polikarbonat

Standardna fino strukturna boja: bijela

Napajanje: 230V/50Hz

Električne komponente: ugrađene u kućište

Izvor svjetla: E27, Dulux D/E i T/E žarulje, T9 cijevi

Difuzor: protublješteća polikarbonatna kapa homogenog efekta

Montaža: pomoću vijaka na strop

Spajanje: skidanjem difuzora dostupne su priključne stezaljke i ostale električne komponente

Housing: self-extinguishing polycarbonate

Standard color: white

Power: 230V/50Hz

Supply unit: built in the housing

Light source: E27, Dulux D/E and T/E bulbs, T9 tubes

Diffuser: anti-glare opal polycarbonate with homogenous effect

Mounting: with screws to the ceiling

Connecting: through removing the diffuser, connection clamps and all other electronic components are available



Art.	W	K	V	xH	kg
E27					
4201127	1xE27	3K/4K	230V	280x100	1,0
4201227	2xE27	3K/4K	230V	380x120	2,0
4201327	3xE27	3K/4K	230V	460x120	3,6
T9					
4201122	1x22W	3K/4K	230V	280x100	1,0
4201872	40+32W	3K/4K	230V	460x120	3,6
Dulux D/E					
4201118	1x18W	3K/4K	230V	280x100	1,0
4201126	1x26W	3K/4K	230V	280x100	1,0
4201218	2x18W	3K/4K	230V	380x120	2,0
4201226	2x26W	3K/4K	230V	380x120	2,5
Dulux T/E					
4201132	1x32W	3K/4K	230V	380x120	1,5
4201142	1x42W	3K/4K	230V	380x120	1,4
4201232	2x32W	3K/4K	230V	460x120	3,6
4201242	2x42W	3K/4K	230V	460x120	3,6

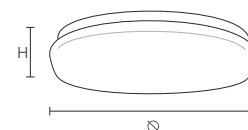

Slični proizvodi
Related products:



AURA
Str. 50

CIRCOLINA art. 4201122

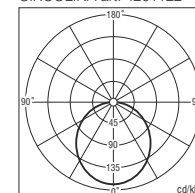

Circolina

Nadgradna LED svjetiljka / Surface mounted LED lamp



Kućište: samogasivi polikarbonat
Standardna fino strukturna boja: bijela
Napajanje: 230V/50Hz
Električne komponente: ugrađene u kućište
Izvor svjetla: LED generacije 3, self-cooling, MacAdam 3 CRI>80; LED min 60.000h L80F50 na $T_p=65^{\circ}\text{C}$; EEI A++
Difuzor: protubliještea polikarbonatna kapa homogenog efekta
Montaža: pomoću vijaka na strop
Spajanje: skidanjem difuzora dostupne su priključne stezaljke i ostale električne komponente

Housing: self-extinguishing polycarbonate
Standard color: white
Power: 230V/50Hz
Supply unit: built in the housing
Light source: LED generation 3, self-cooling; MacAdam 3 CRI>80; LED min 60.000h L80F50 on $T_p=65^{\circ}\text{C}$. EEI A++
Diffuser: anti-glare opal polycarbonate with homogenous effect
Mounting: with screws to the ceiling
Connecting: through removing the diffuser, connection clamps and all other electronic components are available



Art.	W	K	V	lm	xH	kg
LED						
4201721	15,3W	3K/4K	230V	2070/2250	280x100	1,0
4201725	23,1W	3K/4K	230V	2830/3100	280x100	1,5
4201731	18,3W	3K/4K	230V	2600/2740	380x120	1,4
4201735	29,2W	3K/4K	230V	3750/3950	380x120	2,5
4201745	35,0W	3K/4K	230V	4798/5036	460x120	3,6

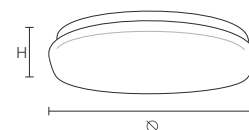

Slični proizvodi
 Related products:



AURA
 Str. 50

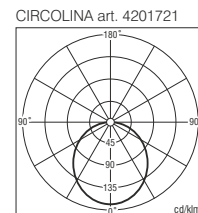



Line

Arhitektura i rasvjeta izražavaju kvalitetu kako našeg životnog prostora tako i naš radni okoliš. U prostoru gdje se dešavaju neprestane promjene, visoka dinamika, statični koncepti unutrašnje opreme i rasvjete nisu usklađeni. Traže se promjene, fleksibilnost i dinamika što se odnosi i na rasvjetu, koja će poštivati različite namjene upotrebe i usklađenje sa dnevnim svjetlom.

LINE nudi sistem rasvjete koji idealno ispunjava zahtjeve po različitoj strukturi rasvjete. Kombinacijom direktne i/ili indirektna rasvjete omogućuje se isceniranje svjetlosti u kancelarijskim prostorima, konferencijskim dvoranama, auto salonima, muzejima, galerijama, trgovačkim centrima.

Architecture and illumination express the quality of our living environment as well as our working space.

In an environment where constant changes are happening with high dynamic, static concept of interior illumination and equipment aren't harmonized. Changes are needed, flexibility and dynamic, which applies onto illumination as well.

LINE offers lighting system which ideally fulfills the needs of specific environment.

By combining direct and/or indirect illumination, light planning for various offices, conference spaces, halls, saloons, museums, shopping centers becomes not only possible but desirable.

NAMJENA / USAGE



Line Slim 40

Zidna svjetiljka sa difuzorom • Wall lamp with diffuser

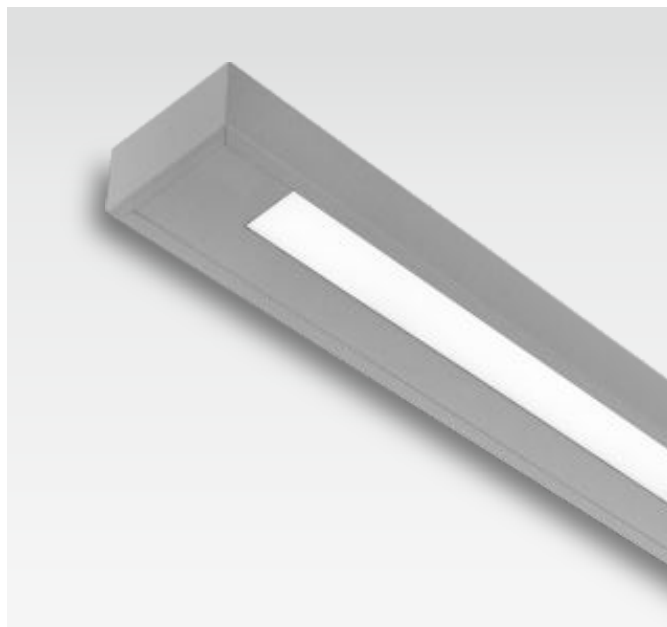

BIJELA/WHITE (W)



ANODIZED AL. (A)



CRNA/BLACK (B)

Kućište: ekstrudirani aluminijski profil

Standardna boja: bijela finostrukturna, anodizirani aluminij, crna finostrukturna

Napajanje: 230V/50Hz

Električne komponente: ugrađene u kućište

Izvor svjetla: Fluo T5 cijev

Difuzor: protubješteći opalni polikarbonat homogenog efekta tehnologije "Crystal Ice"

Montaža: nosačima na zid

Spajanje: na stražnjoj strani svjetiljke dostupne su priključne stezaljke i ostale električne komponente

Prema zahtjevu: regulacijska jedinica DALI, DIM (vidi upute za naručivanje str. 180)

Housing: extruded aluminium profile

Standard color: white finely textured, anodized aluminium, black finely textured

Power: 230V/50Hz

Supply unit: built in the housing

Light source: fluo T5 tube

Diffuser: anti-glare opal diffuser with homogenous effect "Crystal Ice"

Mounting: with carrier to the wall

Connecting: on the rear of the luminaire connection clamps and all other electronic components are available

On request: regulation unit DALI, DIM (see ordering instructions on pg. 180)



Prema zahtjevu:
On request: DALI, DIM

Art.	W	K	V	AxBxH	kg
T5 Direktna distribucija rasvjete / Direct lighting distribution					
2214114	1x14W	3K/4K	230V	640x80x40	2,8
2214124	1x24W	3K/4K	230V	640x80x40	2,8
2214121	1x21W	3K/4K	230V	940x80x40	3,5
2214139	1x39W	3K/4K	230V	940x80x40	3,5
2214128	1x28W	3K/4K	230V	1240x80x40	4,5
2214154	1x54W	3K/4K	230V	1240x80x40	4,5
2214135	1x35W	3K/4K	230V	1540x80x40	5,0
2214149	1x49W	3K/4K	230V	1540x80x40	5,0

Art.	W	K	V	AxBxH	kg
T5 Direkt/indirektna distribucija rasvjete / Direct/indirect lighting distribution					
2214115	1x14W	3K/4K	230V	640x80x40	2,8
2214125	1x24W	3K/4K	230V	640x80x40	2,8
2214122	1x21W	3K/4K	230V	940x80x40	3,5
2214140	1x39W	3K/4K	230V	940x80x40	3,5
2214129	1x28W	3K/4K	230V	1240x80x40	4,5
2214155	1x54W	3K/4K	230V	1240x80x40	4,5
2214136	1x35W	3K/4K	230V	1540x80x40	5,0
2214150	1x49W	3K/4K	230V	1540x80x40	5,0

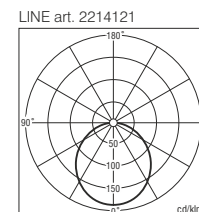
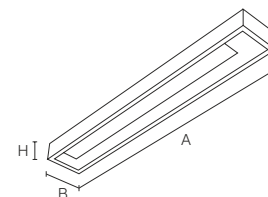

Line quadrant

Nadgradna/viseća svjetiljka / Surface mounted/suspended lamp with "Crystal Ice" diffuser



BIJELA/WHITE (W)



ANODIZED AL. (A)



CRNA/BLACK (B)

Kućište: ekstrudirani aluminijski profil

Standardna boja: bijela, anodizirani aluminiij, crna

Difuzor: protublješteći opalni difuzor homogenog efekta tehnologije "Crystal Ice"

Električne komponente: ugrađene u kućište

Izvor svjetla: fluo Dulux D/E, Dulux L, LED generacije 3, self-cooling, MacAdam 3 CRI>80; LED min 60.000h L80F50 na Tp=65°C; EEI A++

Montaža: vijcima na strop, vješanje na čelične visilice

Spajanje: demontažom difuzora dostupne su priključne stezaljke

Prema zahtjevu: panik, regulacijska jedinica DALI, DIM (vidi upute za naručivanje str. 180)

Housing: extruded aluminium profiles

Standard color: white, anodized aluminium, black

Diffuser: anti-glare opal diffuser with homogenous effect with "Crystal Ice" technology

Supply unit: built in the housing

Light source: fluo Dulux D, Dulux L bulbs, LED generation 3, self-cooling; MacAdam 3 CRI>80; LED min 60.000h L80F50 on Tp=65°C. EEI A++

Mounting: with screws to the ceiling, hanging on steel suspension wires 1x(art.2967)

Connecting: through demounted difuser, connection clamps are available.

On request: emergency light, regulation unit DALI, DIM (see ordering instructions pg. 180)



Prema zahtjevu: EM 1h, EM 3h, DALI, DIM



Ukрасna rozeta s prozirnim dekorativnim kabelom L=1500mm
Decorative box with decorative transparent cable L=1500mm
art. 297



Sajla za vješanje L=1500mm
Hanging wire l=1500mm
art. 296

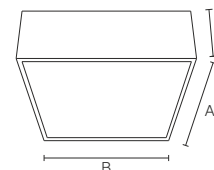

LINE QUADRANT
art. 2001218

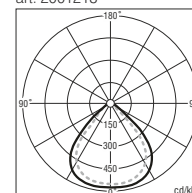

Art.	W	K	V	lm	A x B x H	kg
Dulux D/E						
2001218	2x18W	3K/4K	230V		225x225x100	2,5
2001226	2x26W	3K/4K	230V		225x225x100	2,5
TC-L						
2001219	2x18W	3K/4K	230V		305x305x100	3,6
2001237	2x36W	3K/4K	230V		505x305x100	4,7
2001437	4x36W	3K/4K	230V		505x505x100	5,7
LED						
2001711	15,3W	3K/4K	230V	2070/2250	225x225x100	2,5
2001712	23,1W	3K/4K	230V	2830/3100	225x225x100	2,6
2001721	20,4W	3K/4K	230V	2300/2500	305x305x100	3,6
2001731	26,0W	3K/4K	230V	3720/4050	505x305x100	5,2
2001732	34,1W	3K/4K	230V	4600/5020	505x505x100	5,7

Line quadrant D/I

Viseća Direkt/Indirekt svjetiljka / *Suspended Direct/Indirect lamp*



BIJELA/WHITE (W)



ANODIZED AL. (A)



CRNA/BLACK (B)

Kućište: ekstrudirani aluminijski profil

Standardna boja: bijela, anodizirani aluminij, crna

Difuzor: protublješteći opalni difuzor homogenog efekta tehnologije "Crystal Ice"

Električne komponente: ugrađene u kućište

Izvor svjetla: fluo Dulux D/E, Dulux L

Montaža: vijcima na strop, vješanje na čelične visilice

Spajanje: demontažom difuzora dostupne su priključne stezaljke

Prema zahtjevu: panik, regulacijska jedinica DALI, DIM
(vidi upute za naručivanje str. 180)

Housing: extruded aluminium profiles

Standard color: white, anodized aluminium, black

Diffuser: anti-glare opal diffuser with homogenous effect with "Crystal Ice" technology

Supply unit: built in the housing

Light source: fluo Dulux D, Dulux L bulbs,

Mounting: with screws to the ceiling, hanging on steel suspension wires
1x(art.2967)

Connecting: through demounted diffuser, connection clamps are available.

On request: emergency light, regulation unit DALI, DIM
(see ordering instructions pg. 180)



Prema zahtjevu:
On request:



Art.	W	K	V	A x B x H	kg
Dulux D/E					
2003218	2x18W	3K/4K	230V	225x225x100	2,5
2003226	2x26W	3K/4K	230V	225x225x100	2,5
TC-L					
2003219	2x18W	3K/4K	230V	305x305x100	3,6
2003237	2x36W	3K/4K	230V	505x305x100	4,7
2003437	4x36W	3K/4K	230V	505x505x100	5,7



Ukrasna rozeta s prozirnim dekorativnim kabelom L=1500mm
Decorative box with decorative transparent cable L=1500mm
art. 297



Sajla za vješanje L=1500mm
Hanging wire l=1500mm
art. 296

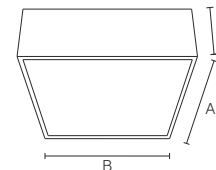

LINE QUADRANT
art. 2003219

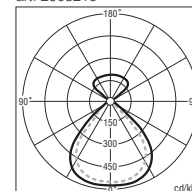

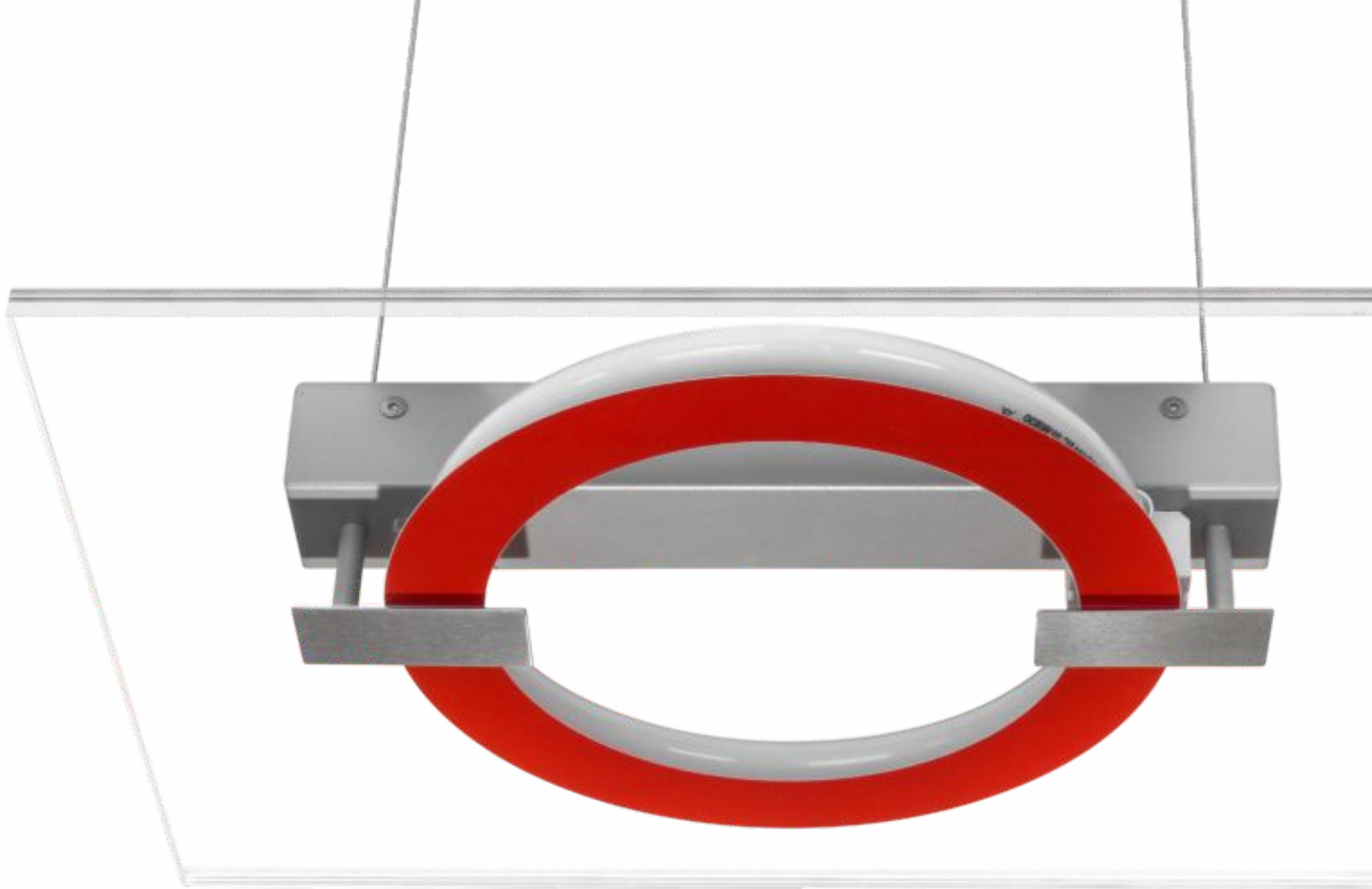

Cercio

Minimalistička zidna/stropna ili viseća lampa sa dekorativnim difuzorom kružnog oblika na transparentnom pravokutnom polikarbonatu visoke kvalitete. Kružni difuzor je dostupan u raznim bojama kako bi omogućili daljnu personalizaciju a metalni detalji su od anodiziranog aluminija. Lampa dolazi u tri varijante i idealna je za dekoraciju stambenih prostora i ureda.

Minimalistic wall/ceiling or suspended luminaire with a decorative ring diffuser on transparent rectangular plexiglass of high quality. The rings are available in multiple colors. Metal details are of anodized aluminium. The luminaire comes in three variations and it's ideal for decorating living spaces and offices.

NAMJENA / USAGE





Cercio

Nadgradna/viseća svjetiljka / Surface/suspended lamp



SIVA/GREY (S) NARANDŽ/ORANGE (F) CRVENA/RED (R) PLAVA/BIJE (U)

Art.	W	K	V	A x B x H	kg
T9					
4121022	1x22W	3K/4K	230V	410x300x85	2,0
4121222	2x22W	3K/4K	230V	650x300x85	2,8
4121322	3x22W	3K/4K	230V	1200x300x85	3,6

Nosač elemenata: prešani čelični lim, električki punktiran i obojen termoeпокsidnom bojom
Standardna boja: siva metalizirana
Difuzor: transparentni polikarbonat s dekorativnim prstenom
Električne komponente: elektronske prigušnice, ugrađene u kućište
Izvor svjetla: fluo okrugle T9 cijevi
Montaža: vijcima na strop/zid, vješanje na čelične visilice
Spajanje: demontažom kućišta dostupne su priključne stezaljke
Prema zahtjevu: regulacijska jedinica DALI, DIM
 (vidi upute za naručivanje str. 180)

Carrier of elements: pressed steel sheet-metal, electrically punctured and covered with thermal epoxy colour
Standard color: metalized gray
Diffuser: transparent polycarbonate with decorative ring
Supply unit: electronic ballast built in the housing
Light source: fluo circular T9 tubes
Mounting: with screws to the ceiling/wall, hanging on steel suspension wires
Connecting: through demounted housing, connection clamps are available.
On request: regulation unit DALI, DIM
 (see ordering instructions pg. 180)

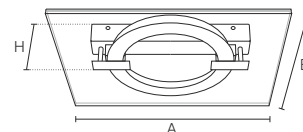
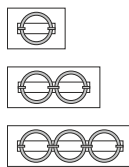

Ukрасna rozeta s prozirnim dekorativnim kabelom L=1500mm
 Decorative box with decorative transparent cable L=1500mm
art. 297



Sajla za vješanje L=1500mm
 Hanging wire l=1500mm
art. 296

CERCIO art. 4121022

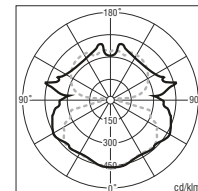



Tiss

Inspiracija svjetlošću i prirodom je neiscrpna i uvijek iznova očaravajuća. I svjetlost i priroda ulaze u sve pore našeg postojanja, grade naše živote, utječu na naše raspoloženje i stanja, reguliraju naš biološki sat. Stoga ne čudi vječna zainteresiranost čovjeka da ih istraži, dokuči, obuzda.

Svjetiljka Tiss slavi prirodu i njezine plodove - sazdana je od prirodnog masivnog drva i njegovana prirodnim voskom. Tiss slavi i posvećenost radu - svoj karakteristični, cilindrični oblik duguje tradicionalnoj podrumarskoj opremi, konkretnije preši za grožđe. Igra svjetla i sjene koju stvara Tiss, prolaskom svjetlosti kroz okomite letvice sjenila daje poseban karakter prostoriji u kojoj se nalazi.

Inspiration with light and nature is inexhaustible and always fascinating. Both the light and the nature are included in all aspects of our existence, build our lives, affect our moods and states, regulate our biological clock. It is therefore not surprising eternal interest of man to explore them, comprehend, curb.

Tiss celebrates nature and it's fruits - composed of natural solid wood and cherished with natural wax. Tiss celebrates work and dedication as well - it's characteristic cylindrical chape invokes traditional cellar equipment, specifically a wine press. The play of light and shadows, created by Tiss, passing through the vertical blinds slats, gives special character and mood to the room it inhabits.



NAMJENA / USAGE



Tiss

Dekorativna drvena svjetiljka / *Decorative wooden lamp*

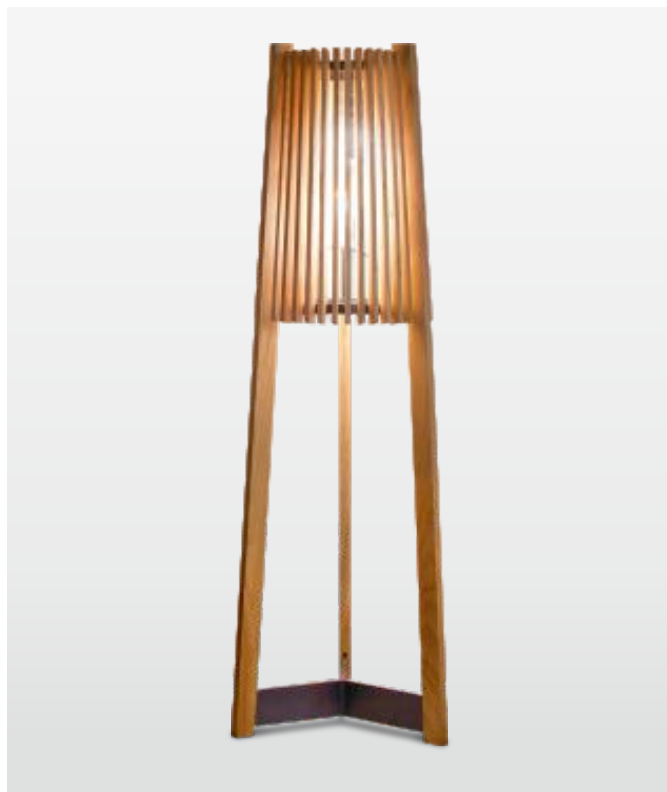

Kućište: od prirodnog masivnog drva jasena
Standardna: prirodno drvo polirano biljnim lakom
Napajanje: 230V/50Hz
Izvor svjetla: E27 ECO žarulje
Spajanje: na priključni kabel
Prema zahtjevu: zaštitni transparentni polikarbonat

Housing: from natural solid ashen wood
Standard color: natural wood polished with vegetable lacquer oil
Power: 230V/50Hz
Diffuser: from protective transparent polycarbonate
Light source: E27 ECO bulbs
Connecting: to connecting cable



Art.	W	K	V	x H
E27 ECO				
4378027	1 x E27	3K/4K	230V	445x1500

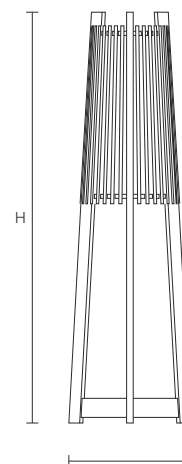
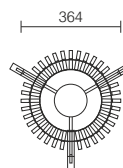



Punta

Dekorativna svjetiljka Punta zidne, stolne i podne varijante.
Detalji svjetiljaka pomno su isplanirani, od kromiranog nosača visoko sjajne kvalitete do sjenila od kaširanog platna koje nježno omekšava i raspršuje svjetlost ostavljajući ugodan i topao ambijent.
Idealne su za hotelske i stambene interijere te svojom nenametljivošću savršeno nadopunjavaju prostore.

*Decorative lamp Punta comes in table, floor and wall mounted version.
Every detail is cleverly planned, from chromed stand of high gloss quality to laminated shadow which gently softens light leaving behind warm and pleasant ambience.
Ideal for tourism and living interiors and with their unassuming presence they fit perfectly in every space.*

NAMJENA / USAGE





Punta wall

Zidna svjetiljka / Wall mounted lamp



Kućište: kromirani nosač iz visoko sjajnog mesinga
Standardna boja: visoko-sjajni kromirani nosač, smeđe UV sjenilo
Napajanje: 230V/50Hz
Izvor svjetla: E27 ECO
Sjenilo: kaširano platno
Montaža: pričvršćenje na zid

Housing: chromed carrier made from highly polished brass
Standard color: high gloss chrome carrier, brown UV shadow
Power: 230V/50Hz
Light source: E27 ECO
Shade: laminated canvas
Mounting: wall mounting



Art.	W	V	A x B x H	kg
E27 ECO				
4294060	1 x E27	230V	275x215x240	2,5

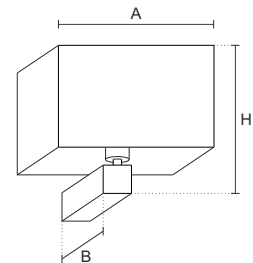

Punta table

Stolna svjetiljka / Table lamp



Kućište: kromirani stalak iz visoko sjajnog mesinga
Standardna boja: visoko-sjajni kromirani nosač, smeđe UV sjenilo
Napajanje: 230V/50Hz
Izvor svjetla: E27 ECO
Sjenilo: kaširano platno

Housing: chromed stand made from highly polished brass
Standard color: high gloss chrome stand, brown UV shadow
Power: 230V/50Hz
Light source: E27 ECO
Shadow: laminated canvas



Art.	W	V	A x B x H
E27 ECO			
4308060	1 x E27	230V	335x260x570

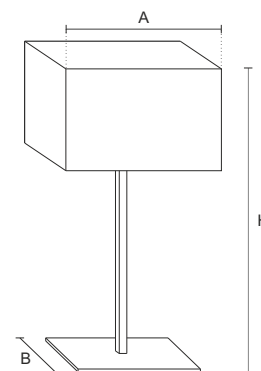

Punta floor

Stolna svjetiljka / Table lamp



Kućište: kromirani stalak iz visoko sjajnog mesinga
Standardna boja: visoko-sjajni kromirani nosač, smeđe UV sjenilo
Napajanje: 230V/50Hz
Izvor svjetla: E27 ECO
Sjenilo: kaširano platno

Housing: chromed stand made from highly polished brass
Standard color: high gloss chrome stand, brown UV shadow
Power: 230V/50Hz
Light source: E27 ECO
Shadow: laminated canvas



Art.	W	V	A x B x H
E27 ECO			
4318060	1 x E27	230V	405x350x1395

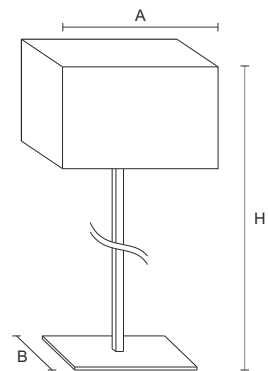





Flame

Flame reflektor je nastao iz želje da se osmisli jedno rasvjetno tijelo sa velikim stupnjem prilagođavanja.

Da li na traci, zidu ili stropu, Flame linija rasvjetnih tijela savršeno se stapa u prostor te naglašava željene zone u prostoru, a izborom šireg ili užeg svjetlosnog snopa ali i mogućnošću usmjeravanja samog tijela, površina i pozicija osvijetljene zone može se kontrolirati.

Kućište reflektora je iz aluminijskog obojenog termoeпокsidnom bojom a izvor svjetlosti je zaštićen zaštitnim polikarbonatom otpornim na temperaturu i udarce.

Flame reflector was created from a need to design one luminaire with great degree of customization.

On track, wall or ceiling, Flame line of luminaires blends seamlessly in space and accentuates the desired zones and with the possibility of choosing wide or narrow light beam as well as orienting the body, the illuminated surface and it's position can be controlled.

The housing of the reflector is made from aluminium coated with thermal epoxy colour and the light source is protected with polycarbonate resistant to temperature and strikes.

NAMJENA / USAGE





PROJECT: Kozlović Winery
PHOTOGRAPHER: Eitor

Flame 75

Nadgradni LED reflektor / Surface mounted LED reflector



BIJELA/WHITE (W)



SIVA/GREY(G)

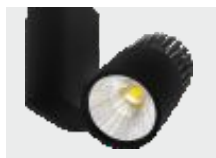

CRNA/BLACK (B)

Art.	△	W	K	V	lm	x A x H	kg
LED							
3401701	42°	17,6W	3K/4K	230V	2593/2673	75x100x123	2,4
3401702	42°	25,5W	3K/4K	230V	3499/3606	75x100x123	2,4
3401703	70°	17,6W	3K/4K	230V	2593/2673	75x100x123	2,4
3401704	70°	25,5W	3K/4K	230V	3499/3606	75x100x123	2,4

Kućište: ekstrudirani aluminij obojan termoeпокsidnom bojom

Standardna finostrukturna boja: bijela, siva, crna

Napajanje: 230V/50Hz

Električne komponente: ugrađene u kućište

Izvor svjetla: LED najnovije generacije koji omogućuju visoku efikasnost i učinkovitost CRI>80; životni vijek LED izvora min 50.000h L70B10 na Tp=65°C; klasa energetske učinkovitosti A+ Kut rotiranja po okomitoj osi 0°-180°, po horizontalnoj osi 0°-355°

Odsijač: iz sjajnog metaliziranog aluminija zaštićen zaštitnim polikarbonatom otpornim na temperaturu i udarce.

Montaža: adapter za montažu na šinu u kompletu

Prema zahtjevu: Baza za nadgradnu montažu art. 435, druge boje izvora svjetlosti, CRI>93 (pogledati upute za naručivanje str. 180)

Housing: extruded aluminium colored thermal epoxy colored

Standard finely structured color: white, grey, black

Power: 230V/50Hz

Supply units: built in the housing

Light source: LED latest generation with asymmetric flood optics that allow high efficiency and effectivity (symmetric on request) CRI>80. Lifetime of LED's 50.000h L70B10 on Tp=65°C. Energy efficiency class A+. Rotating angle on vertical axis 0°-180°, horizontal axis rotating 0°-355°

Reflector: of bright metallized aluminium protected with protective polycarbonate resistant to temperature and strikes

Mounting: adapter for rail mounting in set

On request: base for mounting on ceiling art. 435, other colors of light source, CRI>93 (see ordering instructions on pg. 180)



Prema zahtjevu: CRI >93 RGB



Baza za stropnu montažu
Base for mounting on ceiling
art. 435

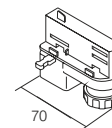
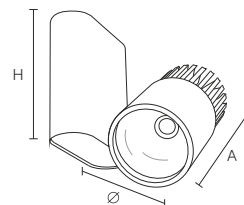

FLAME art. 3401701

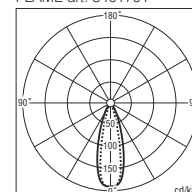

Flame 130

Nadgradni LED reflector / Surface mounted LED reflector

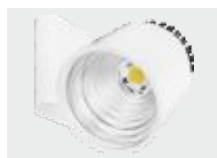
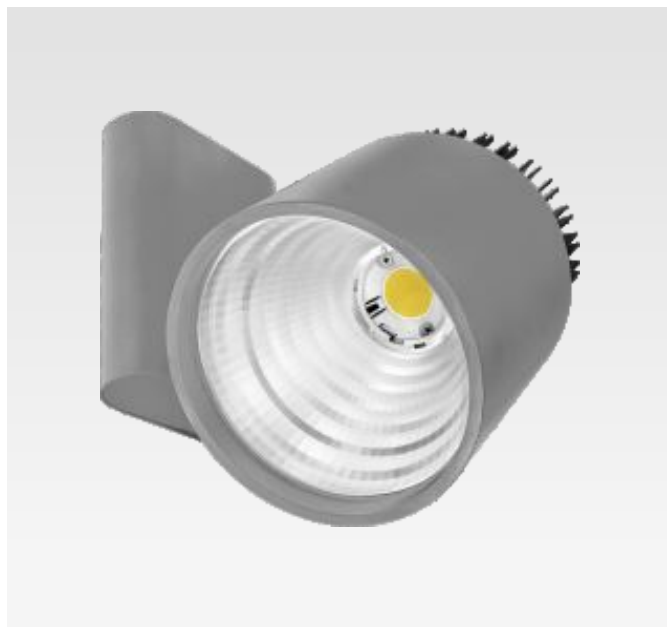

BIJELA/WHITE (W)



SIVA/GREY(G)



CRNA/BLACK (B)

Kućište: aluminij obojan termoeпокsidnom bojom

Standardna finostrukturna boja: bijela, siva, crna

Napajanje: 230V/50Hz

Električne komponente: ugrađene u kućište

Izvor svjetla: LED najnovije generacije koji omogućuju visoku efikasnost i učinkovitost CRI>80; životni vijek LED izvora min 50.000h L70B10 na $T_p=65^\circ\text{C}$; klasa energetske učinkovitosti A+ Kut rotiranja po okomitoj osi $0^\circ-180^\circ$, po horizontalnoj osi $0^\circ-355^\circ$

Odsijač: iz sjajnog metaliziranog aluminija zaštićen zaštitnim polikarbonatom otpornim na temperaturu i udarce.

Montaža: adapter za montažu na šinu u kompletu

Prema zahtjevu: Baza za nadgradnu montažu art. 435, druge boje izvora svjetlosti, CRI>93 (pogledati upute za naručivanje str. 180)

HHousing: aluminium colored thermal epoxy colored

Standard finely structured color: white, grey, black

Power: 230V/50Hz

Supply units: built in the housing

Light source: LED latest generation with asymmetric flood optics that allow high efficiency and effectivity (symmetric on request) CRI>80. Lifetime of LED's 50.000h L70B10 on $T_p=65^\circ\text{C}$. Energy efficiency class A+. Rotating angle on vertical axis $0^\circ-180^\circ$, horizontal axis rotating $0^\circ-355^\circ$

Reflector: of bright metallized aluminium protected with protective polycarbonate resistant to temperature and strikes

Mounting: adapter for rail mounting in set

On request: base for mounting on ceiling art. 435, other colors of light source, CRI>93 (see ordering instructions on pg. 180)



Prema zahtjevu: CRI >93
On request: RGB

Art.	Δ	W	K	V	lm	x A x H	kg
LED							
3411701	39°	24,7W	3K/4K	230V	4010/4134	130x120x144	3,4
3411702	39°	35,2W	3K/4K	230V	5518/5689	130x120x144	3,4
3411703	39°	46,2W	3K/4K	230V	6978/7194	130x120x144	3,4
3411704	39°	54,6W	3K/4K	230V	8042/8291	130x120x144	3,4
3411705	72°	24,7W	3K/4K	230V	4010/4134	130x120x144	3,4
3411706	72°	35,2W	3K/4K	230V	5518/5689	130x120x144	3,4
3411707	72°	46,2W	3K/4K	230V	6978/7194	130x120x144	3,4
3411708	72°	54,6W	3K/4K	230V	8042/8291	130x120x144	3,4



Baza za stropnu montažu
Base for mounting on ceiling
art. 435

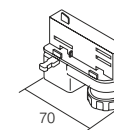
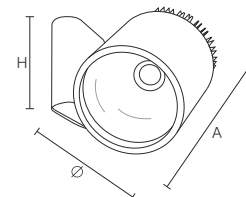

FLAME art. 3411701

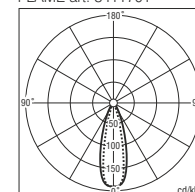



Eltrack

Elektrificirana euro-šina sa tri odvojena strujna kruga, 5 bakrenih vodiča 3mm . Aluminijski profil je moguće rezati na mjeru prema potrebi korisnika. Šina ima predviđene otvore za fiksiranje na strop ili vješanje na visilice. U narudžbi potrebno je navesti boju proizvoda, u protivnom isporučuje se standardna siva boja.

Euro-electrified rails with three separate circuits, 5 copper wires 3mm. Aluminum profile can be cut to measure according to customer needs. Rails have provided openings for fixing on the ceiling or hanging on suspension wires. The customer when ordering must specify the color of the product, otherwise the supplied standard is gray color.

NAMJENA / USAGE



Eltrack

Elektrificirana euro-šina / *Euro electrified rail*



BIJELA/WHITE (W)



SIVA/GRAY. (G)



CRNA/BLACK (B)

Elektrificirana euro-šina sa tri odvojena strujna kruga, 5 bakrenih vodiča 3mm .
Aluminijski profil je moguće rezati na mjeru prema potrebi korisnika. Šina ima predviđene otvore za fiksiranje na strop ili vješanje.
U narudžbi potrebno je navesti boju proizvoda, u protivnom se isporučuje standardna siva boja.

*Euro-electrified rails with three separate circuits, 5 copper wires 3mm.
Aluminum profile can be cut to measure according to customer needs. Rails have provided openings for fixing on the ceiling or suspension. The customer when ordering must specify the color of the product, otherwise standard gray color is supplied.*

IP40 16A

Art.		L	V	AxBxL
3121001	ELTRACK 3	1m	16A	36x33x1000
3121002	ELTRACK 3	2m	16A	36x33x2000
3121003	ELTRACK 3	3m	16A	36x33x3000

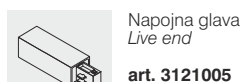
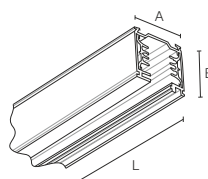

Napojna glava
Live end
art. 3121005

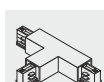

"T" spoj
"T" coupler
art. 3121009



Adapter za svjetiljku
Luminaire adapter
art. 3121013



Linijski spoj
Straight coupler
art. 3121006

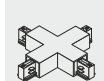

"X" spoj
"X" coupler
art. 3121009



Nosač za stropnu montažu
Clip for ceiling mounting
art. 3121014

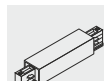

Središnja napojna glava
Straight coupler for central feeding
art. 3121007



Fleksibilni spoj
Flexible coupler
art. 3121011



Ovjesni pribor
Suspension kit
art. 3121015



"L" kutni spoj
"L" angled coupler
art. 3121008

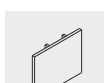

Završni čep
Ending cap
art. 3121012



Kruti ovjesni pribor
Stiff suspension kit
art. 3121016



Star sky

NAMJENA / USAGE



Star sky

Ugradna LED svjetiljka / Recessed LED lamp



BIJELAWHITE (W)



KROM/CHROME (K)

Art.	W	K	V	lm	Ø x H	⌚	kg
LED							
4172701	1,2 W	3K/4K	350mA	93	32x70	22	0,15
4172703	2,5 W	3K/4K	500mA	180	32x70	22	0,15
4172705	RGB 3,8 W	3K/4K	350mA	108	32x70	22	0,18

Kućište: kromirani mesing

Standardna boja: finostrukturna bijela, sjajni krom

Napajanje: 350mA, 700mA

Električne komponente: odvojene napojne jedinice (naručuju se zasebno str 176)

Izvor svjetla: LED najnovije generacije, MacAdam 3 CRI>80; LED min 50.000h L80F50 na $T_p=70^{\circ}\text{C}$; EEI A+

Montaža: u gipsane spuštene stropove ili ugradnja u kutiju za montažu u betonskom stropu

Spajanje: na priključni kabel

Prema zahtjevu: DIM, RGB DMX upravljanje (vidi upute za naručivanje str. 180)

Housing: chromed messing

Standard color: finely-structured white, glossy chrome

Power: 350mA, 700mA

Supply unit: separate supply units (ordered separately pg. 176)

Light source: LED newest generation, MacAdam 3 CRI>80; LED min 60.000h L80F50 on $T_p=70^{\circ}\text{C}$. EEI A+

Mounting: in suspended gypsum ceilings or by inserting it in mounting box for concrete mounting

Connecting: on connection cable

On request: DIM, RGB DMX (see ordering instructions on pg. 180)



Prema zahtjevu:
On request:



Kutija za ugradnju u betonski strop
Box for installation into concrete ceiling
h 80mm, ø 105mm
art.116

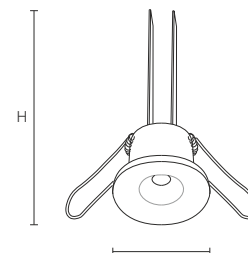

STAR SKY art. 4172701

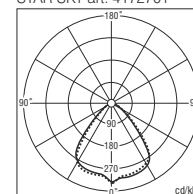



Halo

NAMJENA / USAGE



Halo

Ugradna LED svjetiljka / Recessed LED lamp

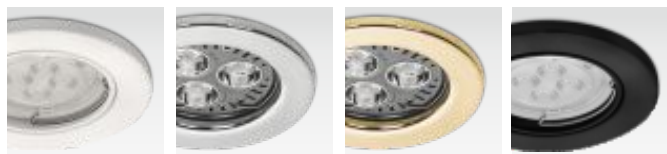

BIJELA/WHITE (W) KROM/CHROME (K) ZLATNA/GOLD (Z) CRNA/BLACK (B)

Art.	W	K	V	lm	xH	⊙	kg
HALO 1 GU10							
3452049	1 x GU10	3K/4K	230V		80x68*	70	0,40
HALO 1 LED							
3452711	10,7W	3K/4K	230V	1100/1200	80x68*	70	0,45
3452712	12,8W			1340/1460			

HALO 2 GU10							
3472049	1 x GU10	3K/4K	230V		84x68*	74	0,50
HALO 2 LED							
3472711	10,7W	3K/4K	230V	1100/1200	84x68*	74	0,55
3472712	12,8W	3K/4K	230V	1340/1460	84x68*	74	0,55

Kućište: prešani čelični lim obojan termoeпокsidnom bojom
Standardna boja: finostrukturna bijela, finostrukturna crna, sjajni krom, zlato
Napajanje: 350mA, 500mA
Električne komponente: odvojene napojne jedinice (naručuju se zasebno str. 176)
Izvor svjetla: GU10 žarulje, LED najnovije generacije, MacAdam 3 CRI>80; LED min 60.000h L80F50 na Tp=65°C; EEI A++
Montaža: u gipsane spuštene stropove ili ugradnja u kutiju za montažu u betonskom stropu
Spajanje: na priključni kabel
Prema zahtjevu: panik, DIM upravljanje (vidi upute za naručivanje str. 180)

Housing: pressed steel sheet metal covered with thermal epoxy color
Standard color: finely-structured white, finely-structured black, glossy chrome, gold

Power: 350mA, 500mA

Supply unit: separate supply units (ordered separately pg. 176)

Light source: GU10 bulbs, LED newest generation, MacAdam 3 CRI>80; LED min 60.000h L80F50 on Tp=65°C. EEI A++

Mounting: in suspended gypsum ceilings or by inserting it in mounting box for concrete mounting

Connecting: on connection cable

On request: emergency light, DIM (see ordering instructions on pg. 180)

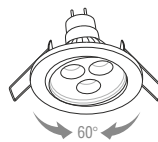
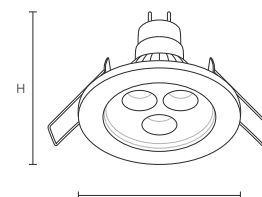
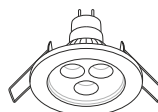

Kutija za ugradnju u betonski strop
 Box for installation into concrete ceiling
 h 70mm, ø 200mm
art. 119

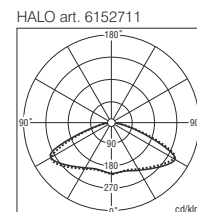



Coin

Ugradne upuštene Coin svjetiljke svojom uvučenim izvorom svjetlosti smanjuju razinu blještavila te prostorima daju minimalistički izgled. Punoća i kvaliteta strukture materijala omogućava kvalitetnu rasvjetljenost i ugodnost ambijenta.

Recessed retracted Coin luminaires with it's retracted light source are lowering glare level and giving minimalistic look to spaces. Fullness and structure quality of it's material allow quality luminance and ambience comfort.

NAMJENA / USAGE





Coin

Ugradna svjetiljka / Recessed lamp



Kućište: prešani čelični lim, obojan termoeпокsidnom finostrukturnom bijelom bojom

Napajanje: 230V/50Hz

Električne komponente: odvojene napojne jedinice (napojne jedinice u kompletu)

Izvor svjetla: GU10 žarulje, LED najnovije generacije, MacAdam 4 CRI > 80; LED min 50.000h L80F50 na $T_p=75^{\circ}\text{C}$; EEI A

Montaža: pričvršćenje u gips pomoću opruga

Prema zahtjevu: regulacijska jedinica DALI, DIM (pogledati upute za naručivanje str. 180)

Housing: pressed steel sheet-metal, covered with thermal epoxy finely-textured white color

Power: 230V/50Hz

Supply unit: separate supply units (supply units included)

Light source: GU10 bulbs, LED newest generation, MacAdam 4 CRI > 80; LED min 50.000h L80F50 on $T_p=75^{\circ}\text{C}$. EEI A

Mounting: mounting in plaster with springs

On request: regulation unit DALI, DIM (see ordering instructions on pg. 180)



Prema zahtjevu:
On request:



Art.	W	K	V	lm	xH		kg
GU10							
3242050	1 x GU10	3K/4K	230V		95x130*	90	0,40
LED							
3242711	10,7W	3K/4K	230V	1100/1200	95x130*	90	0,40
3242713	12,8W	3K/4K	230V	1340/1460	95x130*	90	0,40

* visina može varirati

* height may vary

IP44
Transparentni polikarbonatni difuzor
Transparent polycarbonate diffuser
art. 648

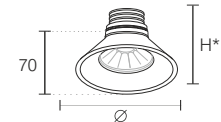

COIN art. 3242711

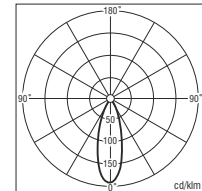

Coin maxi

Ugradna svjetiljka / Recessed lamp



Kućište: prešani čelični lim, obojan termoeпокsidnom finostrukturnom bijelom bojom

Napajanje: 230V/50Hz

Električne komponente: odvojene napojne jedinice za napajanje od 12V (napojne jedinice naručuju se zasebno str. 176)

Izvor svjetla: AR111, metal halogene HCl žarulje i LED najnovije generacije, MacAdam 4 CRI>80; LED min 50.000h L80F50 na Tp=75°C; EEI A

Montaža: pričvršćenje u gips pomoću opruga

Prema zahtjevu: regulacijska jedinica DALI, DIM (vidi upute za naručivanje str. 180)

Housing: pressed steel sheet-metal, covered with thermal epoxy finely-textured white color

Power: 230V/50Hz

Supply unit: separate supply units for 12V (supply units are ordered separately pg. 176)

Light source: AR111, metal-halide HCl bulbs and LED newest generation, MacAdam 4 CRI>80; LED min 50.000h L80F50 on Tp=75°C. EEI A

Mounting: mounting in plaster with springs

On request: regulation unit DALI, DIM (see ordering instructions on pg. 180)

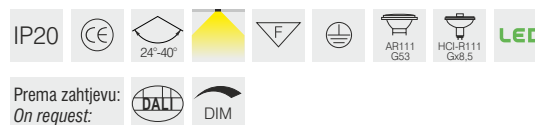

Art.	W	K	V	lm	xH	∠	kg
AR111							
3252100	max 100W	3K/4K	12V		208x130	195	1,5
HCl-R111							
3252135	35W	3K/4K	230V		208x130	195	1,5
3252170	70W	3K/4K	230V		208x130	195	1,5
LED							
3252718	17,3W	3K/4K	230V	1430/1560	208x130	195	1,5
3252723	21,6W	3K/4K	230V	2300/2500	208x130	195	1,5
3252734	32,1W	3K/4K	230V	3300/3600	208x130	195	1,5
3252701	15,5W	3K/4K	230V	1250/1350	208x130	195	1,5
3252702	22,5W	3K/4K	230V	1850/1950	208x130	195	1,5

* visina može varirati

* height may vary

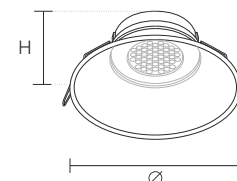

COIN MAXI art. 3252701

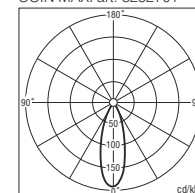

Flash

Vrhunske ugradne svjetiljke visoke kvalitete i elegantnih linija. Osmišljene kao svjetiljke za slaganje u niz i isticanje arhitektonskih značajki prostora. Zbog svog izgleda idealne su za razne studijske prostore ali i trgovine i stambene prostore. Veliki izbor izvedba i boja ali jednostavne montaže pruža Flash liniji svjetiljki veliku prednost nad konvencionalnim rasvjetnim tijelima.

Superior recessed downlight luminaire of high quality and elegant lines. Designed as a luminaire for stacking in series and accentuating architectural elements of space.

Due to its design they are ideal for various studio spaces and shopping interiors.

Great selection of types and colours as well as easy mounting gives Flash line of luminaires great advantage over more conventional luminaires.



NAMJENA / USAGE



Flash mini

Ugradna svjetiljka / Recessed lamp



BIJELAWHITE (W)

SIVA/GRAY. (G)

CRNA/BLACK (B)

Art.	W	K	V	lm	A x A x H	kg
GU10						
3342150	1 x GU10	3K/4K	230V		96x96x80	80x80 0,25
3342250	2 x GU10	3K/4K	230V		176x96x80	160x80 0,50
3342350	3 x GU10	3K/4K	230V		260x100x66	240x85 0,75
3342450	4 x GU10	3K/4K	230V		180x180x66	160x160 1,10
GU5,3						
3342149	1 x GU5,3	3K/4K	12V		96x96x80	80x80 0,25
3342249	2 x GU5,3	3K/4K	12V		176x96x80	160x80 0,50
3342349	3 x GU5,3	3K/4K	12V		260x100x66	240x85 0,75
3342449	4 x GU5,3	3K/4K	12V		180x180x66	160x160 1,10
LED						
3342710	10,7W	3K/4K	230V	1100/1200	96x96x80	80x80 0,25
3342720	21,4W	3K/4K	230V	2200/2400	176x96x80	160x80 0,50
3342730	32,1W	3K/4K	230V	3300/3600	260x100x66	240x85 0,75
3342740	42,8W	3K/4K	230V	4400/4800	180x180x66	160x160 1,10
3342710	12,8W	3K/4K	230V	1340/1460	96x96x80	80x80 0,25
3342720	25,6W	3K/4K	230V	2680/2920	176x96x80	160x80 0,50
3342730	38,4W	3K/4K	230V	4020/4380	260x100x66	240x85 0,75
3342740	51,2W	3K/4K	230V	5360/5840	180x180x66	160x160 1,10

Kućište: čelični lim obojen termoeпокsidnom finostrukturnom bojom

Standardna fino strukturna boja: bijela, siva, crna

Napajanje: 230V/50Hz

Električne komponente: ugrađene u kućište

Izvor svjetla: halogene žarulje GU10 i GU5,3, LED najnovije generacije, MacAdam 4 CRI>80; LED min 50.000h L80F50 na Tp=75°C; EEI A

Montaža: pričvršćenje u strop pomoću opruga

Spajanje: skidanjem kućišta dostupne su priključne stezaljke i ostale električne komponente

Housing: steel sheet-metal covered with thermal epoxy finely textured colour

Standard finely textured color: white, gray, black

Power: 230V/50Hz

Supply unit: built into housing

Light source: halogen bulbs GU10 and GU5,3, LED newest generation, MacAdam 4 CRI>80; LED min 50.000h L80F50 on Tp=75°C. EEI A

Mounting: mounting in ceiling with springs

Connecting: through removing the housing, connection clamps and all other electronic components are available



Ugradna kutija za montažu u beton
Integrated box for installation into concrete
art. 124 - Flash mini 1x
art. 125 - Flash mini 2x
art. 126 - Flash mini 3x
art. 127 - Flash mini 4x

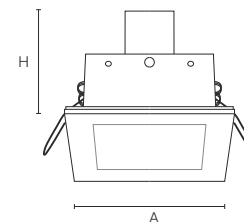

Izvedbe / Variations



Flash 1x

Flash 2x



Flash 3x



Flash 4x

FLASH MINI art. 3342700

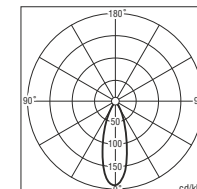

Flash mini opal

Ugradna svjetiljka / Recessed lamp



Kućište: čelični lim obojen termoeпокsidnom finostrukturnom bojom

Napajanje: 230V/50Hz, 12V

Električne komponente: ugrađene u kućište

Izvor svjetla: GU10 žarulje, LED najnovije generacije, MacAdam 4 CRI>80; LED min 50.000h L80F50 na Tp=75°C; EEI A

Difuzor: protubješteći opalni polikarbonat homogenog efekta tehnologije "Cristal Ice"

Montaža: pričvršćenje u strop pomoću opruga

Spajanje: skidanjem kućišta dostupne su priključne stezaljke i ostale električne komponente

Housing: steel sheet-metal covered with thermal epoxy finely textured colour

Power: 230V/50Hz, 12V

Supply unit: built into housing

Light source: GU10 bulbs, LED newest generation, MacAdam 4 CRI>80; LED min 50.000h L80F50 on Tp=75°C. EEI A

Diffuser: anti-glare opal polycarbonate with homogenous effect with "Cristal Ice" technology

Mounting: mounting in ceiling with springs

Connecting: through removing the housing, connection clamps and all other electronic components are available



Art.	W	K	V	lm	A x A x H		kg
GU10							
3542150	1 x GU10	3K/4K	230V		96x96x80	80x80	0,25
GU5,3							
3542149	1 x GU5,3	3K/4K	12V		96x96x80	80x80	0,25
LED							
3242711	10,7W	3K/4K	230V	1100/1200	96x96x80	80x80	0,25
3242713	12,8W	3K/4K	230V	1340/1460	96x96x80	80x80	0,25

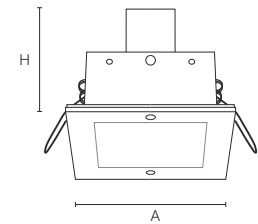

Slični proizvodi
Related products:



QUADRIC
Str. 100

FLASH OPAL art. 3542150

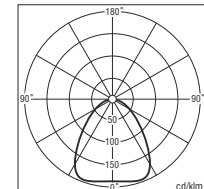

Flash 1

Ugradna svjetiljka / Recessed lamp



BIJELAWHITE (W)

SIVA/GRAY. (G)

CRNA/BLACK (B)

Art.	W	K	V	lm	A x A x H		kg
AR111							
3332101	1 x max 100W	3K/4K	230V		180x180x120	160x160	1,6
LED							
3332711	1 x 17,3W	3K/4K	230V	1430/1560	180x180x120	160x160	1,6
3332712	1 x 21,6W	3K/4K	230V	2300/2500	180x180x175	160x160	1,7
3332713	1 x 32,1W	3K/4K	230V	3470/3780	180x180x175	160x160	1,6
3332714	1 x 15,5W	3K/4K	230V	1250/1350	180x180x175	160x160	1,9
3332715	1 x 22,5W	3K/4K	230V	1850/1950	180x180x175	160x160	1,7

Kućište: čelični lim obojen termoeпокsidnom finostrukturnom bojom

Standardna fino strukturalna boja: bijela, siva, crna

Električne komponente: ugrađene u kućište

Izvor svjetla: AR111 i LED najnovije generacije, MacAdam 4 CRI>80; LED min 50.000h L80F50 na $T_p=75^{\circ}\text{C}$; EEI A

Montaža: pričvršćenje u strop pomičnim nosačima

Spajanje: skidanjem kućišta dostupne su priključne stezaljke i ostale električne komponente

Prema zahtjevu: regulacijska jedinica DALI, DIM (vidi upute za naručivanje str. 180)

Housing: steel sheet-metal covered with thermal epoxy finely textured colour

Standard finely textured color: white, gray, black

Supply unit: built into housing

Light source: AR111 & LED latest generation, MacAdam 4 CRI>80; LED min 50.000h L80F50 na $T_p=75^{\circ}\text{C}$; EEI A

Mounting: mounting in ceiling with adjustable carrier

Connecting: through removing the housing, connection clamps and all other electronic components are available

On request: regulation unit DALI, DIM (see ordering instructions on pg. 180)



Prema zahtjevu:
On request:

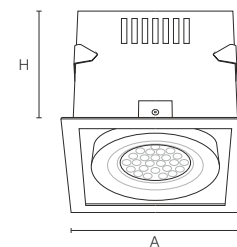

FLASH art. 3332102

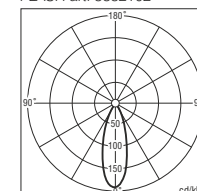

Flash 2

Ugradna svjetiljka / Recessed lamp



BIJELA/WHITE (W)



SIVA/GRAY. (G)



CRNA/BLACK (B)

Art.	W	K	V	lm	A x B x H	kg
AR111						
3332201	2 x max 100W	3K/4K	230V		310x180x120 290x160	2,6
LED						
3332721	2 x 17,3W	3K/4K	230V	2860/3020	310x180x120 290x160	2,5
3332722	2 x 21,6W	3K/4K	230V	4600/5000	310x180x120 290x160	2,6
3332723	2 x 32,1W	3K/4K	230V	6600/7200	310x180x120 290x160	2,5
3332724	2 x 15,5W	3K/4K	230V	2500/2700	310x180x120 290x160	2,8
3332725	2 x 22,5W	3K/4K	230V	3700/3900	310x180x120 290x160	2,6

Kućište: čelični lim obojen termoeпокsidnom finostrukturnom bojom

Standardna fino strukturna boja: bijela, siva, crna

Električne komponente: ugrađene u kućište

Izvor svjetla: AR111 i LED najnovije generacije, MacAdam 4 CRI>80; LED min 50.000h L80F50 na $T_p=75^{\circ}\text{C}$; EEI A

Montaža: pričvršćenje u strop pomičnim nosačima

Spajanje: skidanjem kućišta dostupne su priključne stezaljke i ostale električne komponente

Prema zahtjevu: regulacijska jedinica DALI, DIM (vidi upute za naručivanje str. 180)

Housing: steel sheet-metal covered with thermal epoxy finely textured colour

Standard finely textured color: white, gray, black

Supply unit: built into housing

Light source: AR111 & LED latest generation, MacAdam 4 CRI>80; LED min 50.000h L80F50 na $T_p=75^{\circ}\text{C}$; EEI A

Mounting: mounting in ceiling with adjustable carrier

Connecting: through removing the housing, connection clamps and all other electronic components are available

On request: regulation unit DALI, DIM (see ordering instructions on pg. 180)



Prema zahtjevu:
On request: DALI DIM

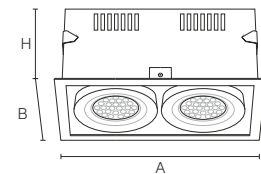

FLASH art. 3332102

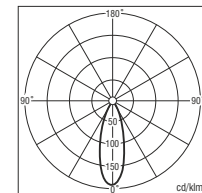



PROJECT: Centre for education - KONZUM
PHOTOGRAPHER: Eltor

Flash 3

Ugradna svjetiljka / Recessed lamp



BIJELA/WHITE (W)



SIVA/GRAY. (G)



CRNA/BLACK (B)

Art.	W	K	V	lm	A x B x H	kg
AR111						
3332301	3 x max 100W	3K/4K	230V		450x180x120 430x160	3,3
LED						
3332731	3 x 17,3W	3K/4K	230V	4290/4680	450x180x120 430x160	3,3
3332732	3 x 21,6W	3K/4K	230V	6900/7500	450x180x120 430x160	3,5
3332733	3 x 32,1W	3K/4K	230V	9900/10800	450x180x120 430x160	3,4
3332734	3 x 15,5W	3K/4K	230V	3750/4050	450x180x120 430x160	3,7
3332735	3 x 22,5W	3K/4K	230V	5550/5850	450x180x120 430x160	3,8

Kućište: čelični lim obojen termoeпокsidnom finostrukturnom bojom

Standardna fino strukturna boja: bijela, siva, crna

Električne komponente: ugrađene u kućište

Izvor svjetla: AR111 i LED najnovije generacije, MacAdam 4 CRI>80; LED min 50.000h L80F50 na $T_p=75^{\circ}\text{C}$; EEI A

Montaža: pričvršćenje u strop pomičnim nosačima

Spajanje: skidanjem kućišta dostupne su priključne stezaljke i ostale električne komponente

Prema zahtjevu: regulacijska jedinica DALI, DIM (vidi upute za naručivanje str. 180)

Housing: steel sheet-metal covered with thermal epoxy finely textured colour

Standard finely textured color: white, gray, black

Supply unit: built into housing

Light source: AR111 & LED latest generation, MacAdam 4 CRI>80; LED min 50.000h L80F50 na $T_p=75^{\circ}\text{C}$; EEI A

Mounting: mounting in ceiling with adjustable carrier

Connecting: through removing the housing, connection clamps and all other electronic components are available

On request: regulation unit DALI, DIM (see ordering instructions on pg. 180)



Prema zahtjevu:
On request: DALI DIM

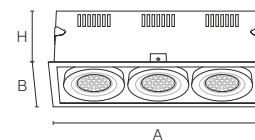

FLASH art. 3332102

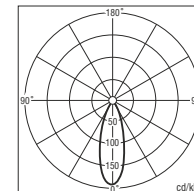

Flash 4

Ugradna svjetiljka / Recessed lamp



BIJELAWHITE (W)



SIVA/GRAY. (G)



CRNA/BLACK (B)

Art.	W	K	V	lm	A x B x H	kg
AR111						
3332401	4 x max 100W	3K/4K	230V		310x310x120	290x290 4,2
LED						
3332741	4 x 17,3W	3K/4K	230V	5720/6240	310x310x120	290x290 4,4
3332742	4 x 21,6W	3K/4K	230V	9200/10000	310x310x120	290x290 4,3
3332743	4 x 32,1W	3K/4K	230V	13200/14400	310x310x120	290x290 4,5
3332744	4 x 15,5W	3K/4K	230V	5000/5400	310x310x120	290x290 4,8
3332745	4 x 22,5W	3K/4K	230V	7400/7800	310x310x120	290x290 4,5

Kućište: čelični lim obojen termoeпокsidnom finostrukturnom bojom

Standardna fino strukturalna boja: bijela, siva, crna

Električne komponente: ugrađene u kućište

Izvor svjetla: AR111 i LED najnovije generacije, MacAdam 4 CRI>80; LED min 50.000h L80F50 na $T_p=75^{\circ}\text{C}$; EEI A

Montaža: pričvršćenje u strop pomičnim nosačima

Spajanje: skidanjem kućišta dostupne su priključne stezaljke i ostale električne komponente

Prema zahtjevu: regulacijska jedinica DALI, DIM (vidi upute za naručivanje str. 180)

Housing: steel sheet-metal covered with thermal epoxy finely textured colour

Standard finely textured color: white, gray, black

Supply unit: built into housing

Light source: AR111 & LED latest generation, MacAdam 4 CRI>80; LED min 50.000h L80F50 na $T_p=75^{\circ}\text{C}$; EEI A

Mounting: mounting in ceiling with adjustable carrier

Connecting: through removing the housing, connection clamps and all other electronic components are available

On request: regulation unit DALI, DIM (see ordering instructions on pg. 180)



Prema zahtjevu: DALI, DIM

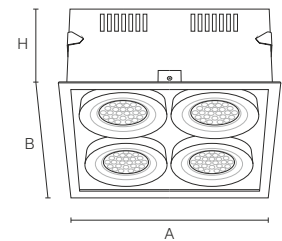

FLASH art. 3332102

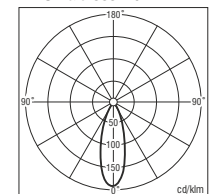

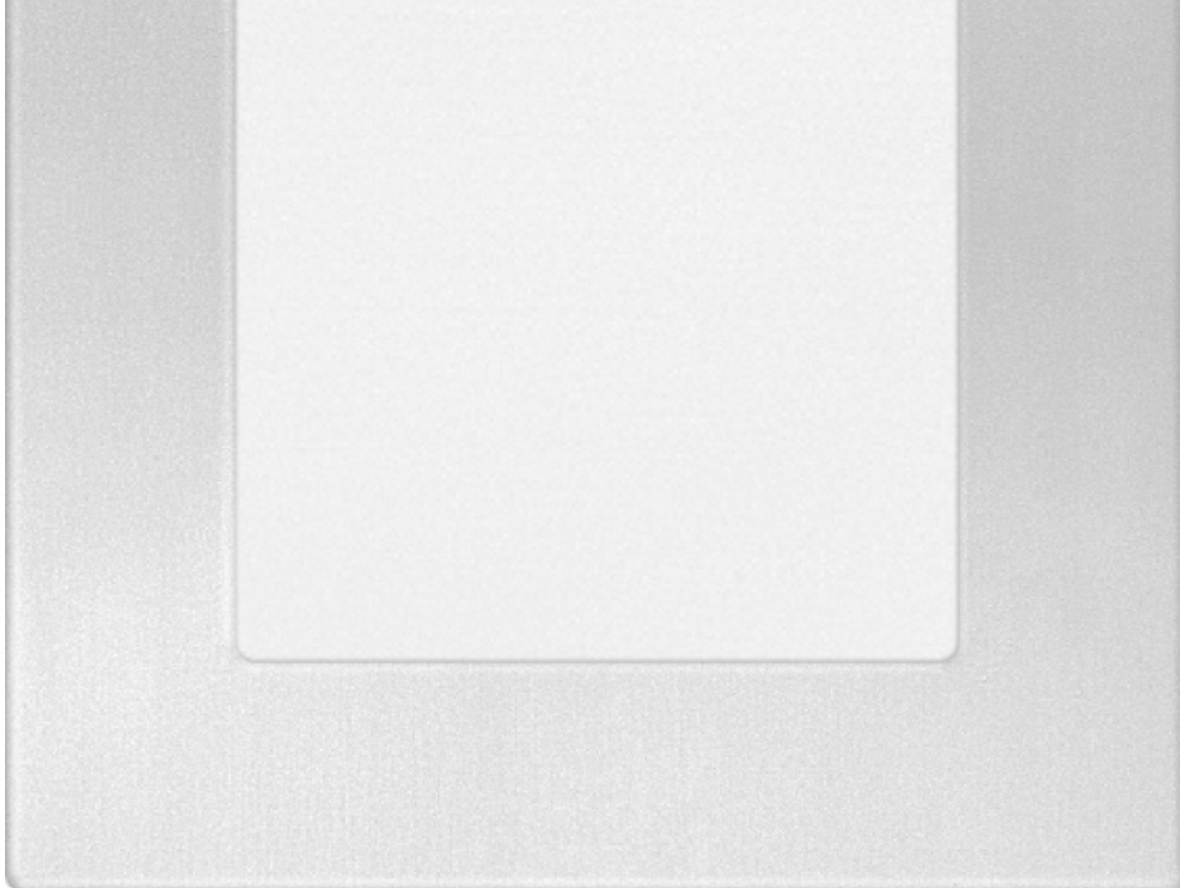

Quadric

Vrhunske ugradne svjetiljke visoke kvalitete i čvrstoće.
Protublješteći opalni polikarbonatni difuzor homogenog efekta oplemenjuje svjetiljku svojim visokim stupnjem uniformiranosti svjetlosnog toka tehnologije "crystal ice".
Idealne kako za unutarnju tako i za vanjsku upotrebu a otporne su na sve vremenske uvjete

*Superior recessed downlight luminaire of high quality.
Opal polycarbonate diffuser with soft effect enriches the lamp with it's uniform luminous flux made possible by "crystal ice" technology. Quadric luminaires are ideal for interior and exterior use and are resistant to all weather conditions*

NAMJENA / USAGE



Quadric

Ugradna LED svjetiljka / Recessed LED lamp

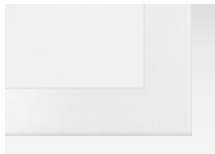
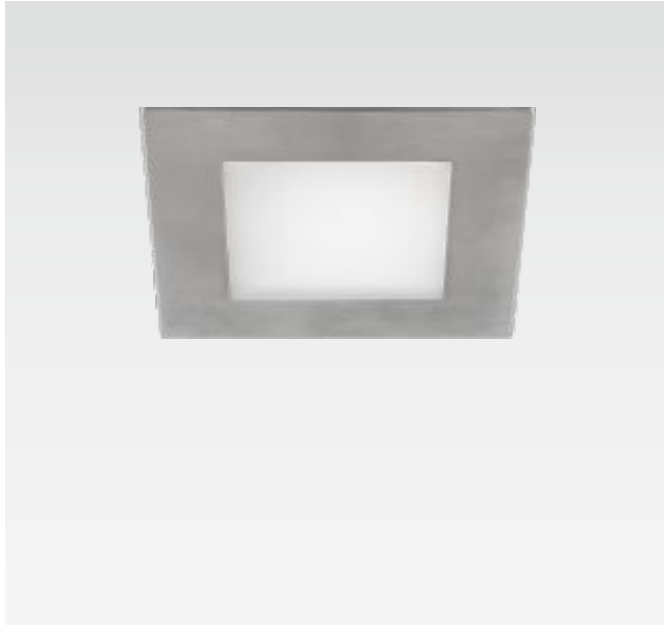

BIJELA/WHITE (W)



ANODIZED AL. (A)



CRNA/BLACK (B)

Art.	W	K	V	A x B x H		kg
LED						
3212700	1,2W	3K/4K	230V	80x80x75	73x73	0,4
3212701	2,0W	3K/4K	230V	80x80x75	73x73	0,4

Kućište: prešani čelični lim obojen termoeпокsidnom bojom, okvir iz inox AISI 316L

Standardna boja: Inox AISI 316L, bijela i crna za vanjske uvjete, samoodržavajuća (antistatična)

Napajanje: 230V/50Hz

Električne komponente: ugrađene u kućište

Izvor svjetla: LED najnovije generacije koji omogućuju visoku efikasnost i učinkovitost CRI>80. Životni vijek LED izvora min 50.000h L70B10 na Tp=65°C. Klasa energetske učinkovitosti A+

Difuzor: protubljesteći opalni polikarbonat homogenog efekta tehnologije "Cristal Ice"

Montaža: držačima u otvor ili ugradnu kutiju

Spajanje: skidanjem svjetiljke dostupne su priključne stezaljke i ostale električne komponente

Housing: steel pressed sheet-metal covered with thermal epoxy colour, frame from inox AISI 316L

Standard color: inox AISI 316L, external white & black, self cleaning (anti-static)

Power: 230V/50Hz

Supply unit: built in the housing

Light source: LED latest generation with asymmetric flood optics that allow high efficiency and effectivity (symmetric on request) CRI>80. Lifetime of LED's 60.000h L70B10 on Tp=65°C. Energy efficiency class A+

Diffuser: anti-glare opal polycarbonate with homogenous effect with "Cristal Ice" technology

Mounting: with holders into opening

Connecting: through removing the luminaire, connection clamps and all other electronic components are available



IP65
Zaljevanje - IP65
Sealing - IP65
art. 146

Ugradna kutija za montažu u beton
Integrated box for installation into concrete
72x72x85mm
art.120

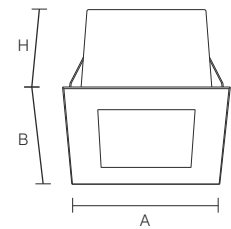

Slični proizvodi
Related products:



FLASH MINI OPAL
Str. 93

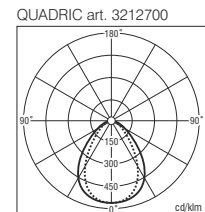

Edge

Vrhunske ugradne downlight svjetiljke visoke kvalitete.
Opalni polikarbonatni difuzor homogenog efekta oplemenjuje svjetiljku svojim visokim stupnjem uniformiranosti svjetlosnog toka tehnologije "crystal ice".
Edge svjetiljke dolaze u pravokutnoj i kružnoj izvedbi.
Idealne za osvjjetljenje različitih prostora i objekata raznih namjena.

*Superior recessed downlight luminaire of high quality.
Opal polycarbonate diffuser with soft effect enriches the lamp with its uniform luminous flux made possible by "crystal ice" technology.
Edge luminaire comes in square and circular variation.
Ideal for illuminating various spaces and buildings of different purposes.*

NAMJENA / USAGE





PROJECT: Restaurant Klarisa
PHOTOGRAPHER: Eltor

Edge square

Ugradna LED svjetiljka / Recessed LED lamp

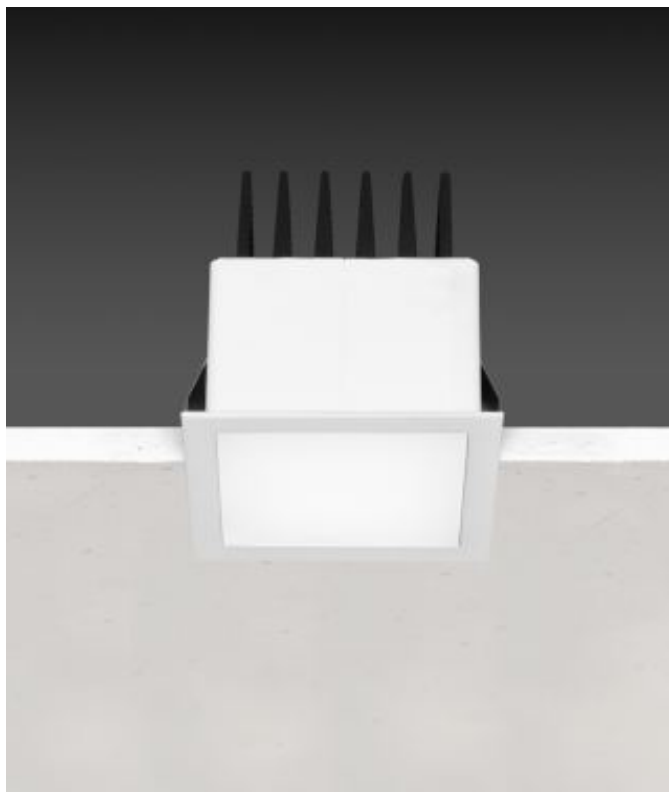

Kućište: čelični lim obojen termoeпокsidnom finostrukturnom bijelom bojom

Napajanje: 230V/50Hz

Električne komponente: odvojene naponske jedinice (napojne jedinice u kompletu)

Izvor svjetla: LED najnovije generacije, MacAdam 3 CRI>80; LED min 60.000h L80F50 na $T_p=65^{\circ}\text{C}$; EEL A++

Difuzor: protubliješćeci opalni difuzor homogenog efekta tehnologije "Crystal Ice"

Montaža: pomoću opruga u otvor

Spajanje: na stražnjoj strani svjetiljke dostupne su priključne stezaljke i ostale električne komponente

Prema zahtjevu: regulacijska jedinica DALI, DIM (vidi upute za naručivanje str. 180)

Housing: steel sheet-metal covered with thermal epoxy finely textured white colour

Power: 230V/50Hz

Supply unit: separate supply units (supply units included)

Light source: LED newest generation, MacAdam 3 CRI>80; LED min 60.000h L80F50 on $T_p=65^{\circ}\text{C}$. EEL A++

Diffuser: anti-glare opal diffuser with homogenous effect with "Crystal Ice" technology

Mounting: with springs into opening

Connecting: connection clamps and all other electronic components are available on the rear side of the luminaire

On request: regulation unit DALI, DIM (see ordering instructions on pg. 180)



Prema zahtjevu: DALI, DIM

Art.	W	K	V	lm	A x A x H		kg
LED							
3502715	8,4W	3K/4K	230V	1288/1329	70x70x75	61x61	0,3
3502725	12,2W	3K/4K	230V	1760/1816	97x97x80	88x88	0,5
3502735	17,6W	3K/4K	230V	2593/2673	133x133x90	124x124	0,8
3502745	24,7W	3K/4K	230V	4010/4134	162x162x90	153x153	0,9

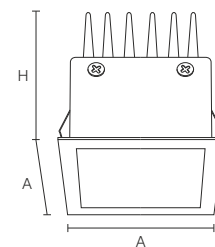

EDGE SQUARE art. 3502745

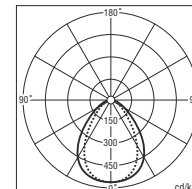

Edge round

Ugradna LED svjetiljka / Recessed LED lamp



Kućište: čelični lim obojen termoeпокsidnom finostrukturnom bijelom bojom

Napajanje: 230V/50Hz

Električne komponente: odvojene naponske jedinice (napojne jedinice u kompletu)

Izvor svjetla: LED najnovije generacije, MacAdam 3 CRI>80; LED min 60.000h L80F50 na Tp=65°C; EEI A++

Difuzor: protublješteći opalni difuzor homogenog efekta tehnologije "Crystal Ice"

Montaža: pomoću opruga u otvor

Spajanje: na stražnjoj strani svjetiljke dostupne su priključne stezaljke i ostale električne komponente

Prema zahtjevu: regulacijska jedinica DALI, DIM (vidi upute za naručivanje str. 180)

Housing: steel sheet-metal covered with thermal epoxy finely textured white colour

Power: 230V/50Hz

Supply unit: separate supply units (supply units included)

Light source: LED newest generation, MacAdam 3 CRI>80; LED min 60.000h L80F50 on Tp=65°C. EEI A++

Diffuser: anti-glare opal diffuser with homogenous effect with "Crystal Ice" technology

Mounting: with springs into opening

Connecting: connection clamps and all other electronic components are available on the rear side of the luminaire

On request: regulation unit DALI, DIM (see ordering instructions on pg. 180)



Prema zahtjevu:
On request: DALI, DIM

Art.	W	K	V	lm	Ø x H	Ø	kg
LED							
3512715	8,4W	3K/4K	230V	1288/1329	80x65	70	0,5
3512725	12,2W	3K/4K	230V	1760/1816	100x90	90	0,5
3512735	17,6W	3K/4K	230V	2593/2673	140x105	130	0,8
3512745	35,2W	3K/4K	230V	5518/5689	170x105	160	1,1

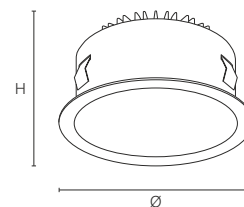

EDGE ROUND art. 3512745

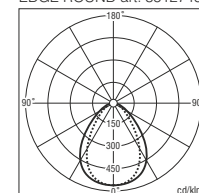



Edra

Ugradna svjetiljka kružnog oblika iz lijevanog aluminija obojanog termoeпокsidnom bojom, sa parabolom od 99,9% metaliziranog aluminija.

Seriya svjetiljaka Edra dolazi u tri boje te sa izborom dekorativnih kaljenih zaštitnih stakala različitih završnih obrada čime omogućavaju visoku razinu personalizacije ovog rasvjetnog tijela te uklapanje u stilski raznovrsne interijere.

Recessed circular luminaire made from pressed aluminium coated with thermal epoxy color, with parabolic made form 99% metallized aluminium.

Edra line of luminaires are available in three colors and a range of decorative tempered glass finishes which allows a high degree of personalisation and expression in designing interior illumination.

NAMJENA / USAGE



Edra

Ugradna svjetiljka / Recessed lamp



BIJELA/WHITE (W)



SIVA/GREY (G)



CRNA/BLACK (B)

Kućište: dekorativni prsten izrađen iz prešanog aluminija obojenog termoeпокsidnom bojom

Standardna fino strukturna boja: bijela, siva, crna

Napajanje: 230V/50Hz

Električne komponente: odvojene naponske jedinice (napojne jedinice u kompletu)

Izvor svjetla: Dulux D/E i T/E žarulje

Montaža: pomoću opruga u otvor

Spajanje: na stražnjoj strani svjetiljke dostupne su priključne stezaljke i ostale električne komponente

Prema zahtjevu: panik, regulacijska jedinica DALI, DIM (vidi upute za naručivanje str. 180)

Housing: decorative ring made from pressed aluminium covered with thermal epoxy color

Standard finely structured color: white, gray, black

Power: 230V/50Hz

Supply unit: separate supply units (supply units included)

Light source: Dulux D/E and T/E bulbs

Mounting: with springs into opening

Connecting: connection clamps and all other electronic components are available on the rear side of the luminaire

On request: emergency module, regulation unit DALI, DIM (see ordering instructions on pg. 180)



Prema zahtjevu: EM 1h, EM 3h, DALI, DIM

Art.	W	K	V	xH	°	kg
Dulux D/E						
3802113	1x13W	3K/4K	230V	250x120	235	1,8
3802213	2x13W	3K/4K	230V	250x120	235	1,9
3802118	1x18W	3K/4K	230V	250x120	235	1,8
3802218	2x18W	3K/4K	230V	250x120	235	1,9
3802126	1x26W	3K/4K	230V	250x120	235	1,8
3802226	2x26W	3K/4K	230V	250x120	235	1,9
Dulux T/E						
3802132	1x32W	3K/4K	230V	250x120	235	1,8
3802232	2x32W	3K/4K	230V	250x120	235	1,9
3802142	1x42W	3K/4K	230V	250x120	235	1,8
3802242	2x42W	3K/4K	230V	250x120	235	1,9

Prozirno kaljeno staklo
Protective transparent glass

art. 608

Opalno kaljeno staklo
Protective opal glass

art. 609

Prozirno dekorativno staklo
Protective transparent glass

art. 610

Ugradna kutija za montažu u beton
Box for installation into concrete
h 170mm, ø 255mm

art. 100

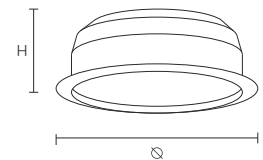

EDRA art. 3802113

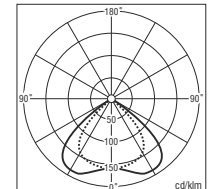



Edra

Ugradna LED svjetiljka / Recessed LED lamp



BIJELA/WHITE (W)



SIVA/GREY (G)



CRNA/BLACK (B)

Art.	W	K	V	lm	xH	∅	kg
LED							
3802717	17,6W	3K/4K	230V	2593/2676	250x120	235	1,8
3802726	25,5W	3K/4K	230V	3499/3606	250x120	235	1,9
3802732	33,8W	3K/4K	230V	4343/4477	250x120	235	1,8

Kućište: dekorativni prsten izrađen iz prešanog aluminija obojenog termoeпокsidnom bojom

Standardna fino strukturna boja: bijela, siva, crna

Napajanje: 230V/50Hz

Električne komponente: ugrađene u kućište

Izvor svjetla: LED najnovije generacije koji omogućuju visoku efikasnost i učinkovitost CRI>80; životni vijek LED izvora min 50.000h L70B10 na Tp=65°C; klasa energetske učinkovitosti A+

Montaža: pomoću opruga u otvor

Prema zahtjevu: regulacijska jedinica DALI, DIM (pogledati upute za naručivanje str. 180)

Housing: decorative ring made from pressed aluminium covered with thermal epoxy color

Standard finely structured color: white, gray, black

Power: 230V/50Hz

Supply unit: built in the housing

Light source: LED latest generation with asymmetric flood optics that allow high efficiency and effectivity (symmetric on request) CRI>80. Lifetime of LED's 50.000h L70B10 on Tp=65°C. Energy efficiency class A+

Mounting: with springs into opening

On request: regulation unit DALI, DIM (see ordering instructions on pg. 180)



Prema zahtjevu:
On request:



Prozirno kaljeno staklo
Protective transparent glass

art. 608

Opalno kaljeno staklo
Protective opal glass

art. 609

Prozirno dekorativno staklo
Protective transparent glass

art. 610

Ugradna kutija za montažu u beton
Box for installation into concrete
h 170mm, ø 255mm

art. 100

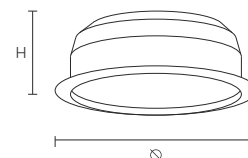

EDRA art. 3802717

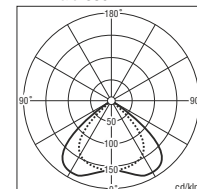



Eden

Nadgradna svjetiljka kružnog oblika iz lijevanog aluminija obojanog termoeпокsidnom bojom, sa parabolom od 99,9% metaliziranog aluminija.

Seriya svjetiljaka Eden dolazi u tri boje te sa izborom dekorativnih kaljenih zaštitnih stakala različitih završnih obrada čime omogućavaju visoku razinu personalizacije ovog rasvjetnog tijela te uklapanje u stilski raznovrsne interijere.

Surface mounted circular luminaire made from pressed aluminium coated with thermal epoxy color, with parabolic made from 99% metallized aluminium.

Eden line of luminaires are available in three colors and a range of decorative tempered glass finishes which allows a high degree of personalisation and expression in designing interior illumination.

NAMJENA / USAGE



Eden

Nadgradna/viseća svjetiljka / *Surface mounted/suspended lamp*



BIJELA/WHITE (W)



SIVA/GREY (G)



CRNA/BLACK (B)

Kućište: prešani aluminij obojen termoeпокsidnom bojom

Standardna fino strukturna boja: bijela, siva, crna

Napajanje: 230V/50Hz

Električne komponente: ugrađene u kućište

Izvor svjetla: Dulux D/E i T/E žarulje

Montaža: pomoću vijaka na strop

Prema zahtjevu: panik, DALI, DIM (pogledati upute za naručivanje str. 180)

Housing: pressed aluminium covered with thermal epoxy color

Standard finely structured color: white, gray, black

Power: 230V/50Hz

Supply unit: built in the housing

Light source: Dulux D/E and T/E bulbs

Mounting: with screws to the ceiling

On request: DALI, DIM (see ordering instructions on pg. 180)



Prema zahtjevu:
On request:



Art.	W	K	V	xH	kg
Dulux D/E					
3161113	1x13W	3K/4K	230V	250x180	3,0
3161213	2x13W	3K/4K	230V	250x180	3,0
3161118	1x18W	3K/4K	230V	250x180	3,0
3161218	2x18W	3K/4K	230V	250x180	3,4
3161126	1x26W	3K/4K	230V	250x180	3,4
3161226	2x26W	3K/4K	230V	250x180	3,9
Dulux T/E					
3161132	1x32W	3K/4K	230V	250x180	3,1
3161232	2x32W	3K/4K	230V	250x180	3,4
3161142	1x42W	3K/4K	230V	250x180	3,1
3161242	2x42W	3K/4K	230V	250x180	3,4

Prozirno kaljeno staklo
Protective transparent glass

art. 608

Opalno kaljeno staklo
Protective opal glass

art. 609

Prozirno dekorativno staklo
Protective transparent glass

art. 610

Ovjesni pribor: Ukrasna rozeta s prozirnim dekorativnim kabelom 3 x saja za vješanje L=1500mm
Hanging set: Decorative box with decorative transparent cable Hanging wire L=1500mm

art. 204

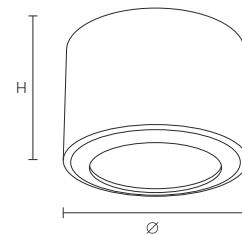

EDEN art. 3802218

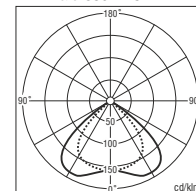

Eden

Nadgradna/viseća LED svjetiljka / Surface mounted/suspended LED lamp



BIJELA/WHITE (W)

SIVA/GREY (G)

CRNA/BLACK (B)

Art.	W	K	V	lm	xH	kg
LED						
3161717	17,6W	3K/4K	230V	2593/2676	250x180	3,2
3161726	25,5W	3K/4K	230V	3499/3606	250x180	3,4

Kućište: prešani aluminij obojen termoepoksidnom bojom

Standardna fino strukturalna boja: bijela, siva, crna

Napajanje: 230V/50Hz

Električne komponente: ugrađene u kućište

Izvor svjetla: LED najnovije generacije koji omogućuju visoku efikasnost i učinkovitost CRI>80; životni vijek LED izvora min 50.000h L70B10 na

Tp=65°C; klasa energetske učinkovitosti A+

Montaža: pomoću vijaka na strop

Prema zahtjevu: panik, DALI, DIM (pogledati upute za naručivanje str. 180)

Housing: pressed aluminium covered with thermal epoxy color

Standard finely structured color: white, gray, black

Power: 230V/50Hz

Supply unit: built in the housing

Light source: LED latest generation with asymmetric flood optics that allow high efficiency and effectivity (symmetric on request) CRI>80. Lifetime of LED's 50.000h L70B10 on Tp=65°C. Energy efficiency class A+

Mounting: with screws to the ceiling

On request: DALI, DIM (see ordering instructions on pg. 180)



Prema zahtjevu:
On request:



 Prozirno kaljeno staklo
Protective transparent glass
art. 608

 Opalno kaljeno staklo
Protective opal glass
art. 609

 Prozirno dekorativno staklo
Protective transparent glass
art. 610

 Ovjesni pribor: Ukrasna rozeta s prozirnim dekorativnim kabelom 3 x sajla za vješanje L=1500mm
Hanging set: Decorative box with decorative transparent cable 3 x sajlja for hanging L=1500mm
art. 204

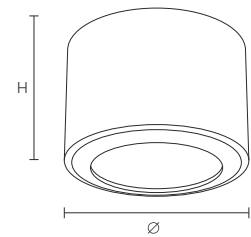

EDEN art. 3802717

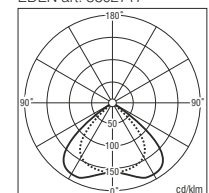





Ecos

Ugradne spotlight svjetiljke Ecos sa kućištem iz ljevanog aluminija obojenog termoepoksidnom bojom idealne su za ugradnju u različite stambene prostore a odlikuje ih visoka IP zaštita koja omogućava rad lampe i u najtežim uvjetima.

Diffuzor od protublješćeg opalnog polikarbonata homogenog efekta omekšava i jednakomjerno raspršuje svjetlost a montaža same svjetiljke je jednostavna zahvaljujući montažnim oprugama.

Recessed spotlight luminaires Ecos with housing made from die cast aluminium body, covered with thermal epoxy color are ideal for usage in various living areas and are characterized by high IP protection rating which allows the luminaire to function in even the harshest environments. Anti-glare opal diffuser with homogenous effect "Crystal Ice" softens and evenly spreads the light and the mounting of the luminaire with springs has never been easier

NAMJENA / USAGE



Ugradna svjetiljka / Recessed lamp

**Kućište:** lijevani aluminij obojen termoeпокsidnom bijelom bojom**Napajanje:** 230V/50Hz**Električne komponente:** ugrađene u kućište**Izvor svjetla:** GU10 žarulje**Difuzor:** protublješteći opalni polikarbonat homogenog efekta tehnologije "Crystal Ice"**Montaža:** u gipsane spuštene stropove ili ugrađnja u kutiju za montažu u betonskom stropu**Housing:** die cast aluminum body, covered with thermal epoxy white color**Power:** 230V/50Hz**Supply unit:** built into housing**Light source:** GU10 bulbs**Diffuser:** anti-glare opal polycarbonate with homogenous effect with "Crystal Ice" technology**Mounting:** in lowered plaster ceiling or inserting in mounting box for concrete ceiling

Art.	W	K	V	x H		kg
GU10						
3202749	1 x GU10	3K/4K	230V	100x78	92	0,42



Kutija za ugrađnju u betonski strop
Box for installation into concrete ceiling
h 70mm, ø 200mm
art. 119

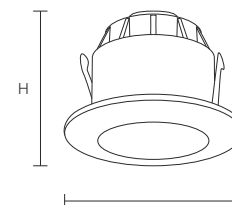

ECOS art. 3202749

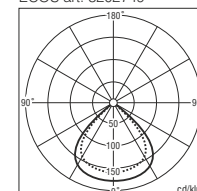

Windy

Elegantne ugradne svjetiljke nenametljivog dizajna Windy idealno su riješenje za moderne stambene prostore, urede i ostale interijere. Osmišljene i dizajnirane kao nadopuna prostoru te svojim oblikom dopuštaju naglašavanje osobina prostora bez narušavanja stilističkog izričaja istog.

Difuzor od protublještećeg opalnog polikarbonata homogenog efekta omekšava i jednakomjerno raspršuje svjetlost a montaža same svjetiljke je jednostavna zahvaljujući montažnim oprugama.

Elegant recessed luminaires Windy with it's unobtrusive design are ideal solution for modern living spaces, offices and other interiors.

Designed and developed as an addition to the interior, with it's shape they accentuate the space without competing with the stylistic expression of one.

Anti-glare opal diffuser with homogenous effect "Crystal Ice" softens and evenly spreads the light and the mounting of the luminaire with springs has never been easier

NAMJENA / USAGE



Windy

Ugradna svjetiljka / Recessed lamp

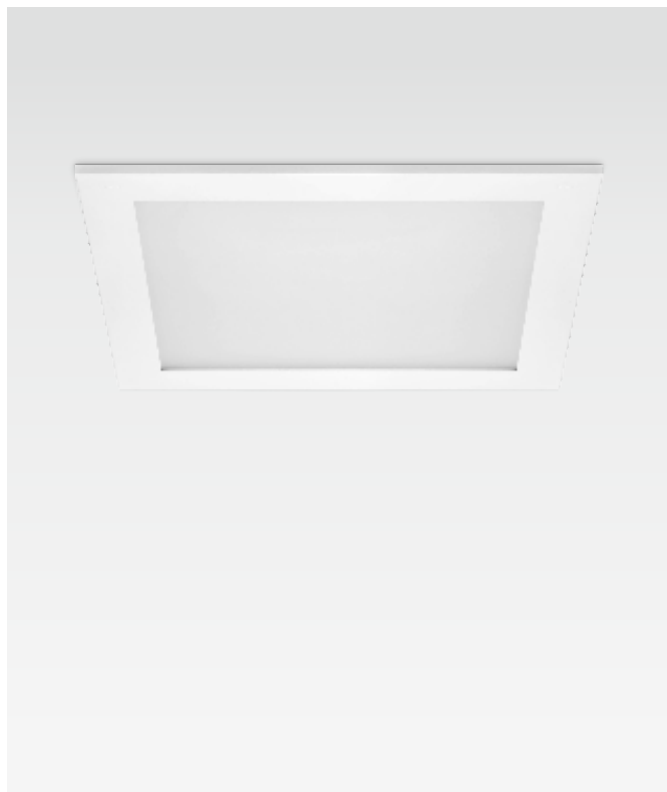

Kućište: prešani aluminij obojan termoeпокsidnom bojom

Standardna fino strukturna boja: bijela, siva, crna

Napajanje: 230V/50Hz

Električne komponente: ugrađene u kućište

Izvor svjetla: Dulux D/E i T/E žarulje

Difuzor: protublješteći opalni polikarbonat homogenog efekta tehnologije "Crystal Ice"

Montaža: pomoću nosača u otvor

Spajanje: demontažom difuzora dostupne su priključne stezaljke

Prema zahtjevu: panik, DALI, DIM (pogledati upute za naručivanje str. 180)

Housing: pressed aluminium covered with thermal epoxy color

Standard color: white, gray, black

Power: 230V/50Hz

Supply unit: built in the housing

Light source: Dulux D/E and T/E bulbs

Diffuser: anti-glare opal diffuser with homogenous effect "Crystal Ice"

Mounting: with holders into opening

Connecting: through demounting the diffuser, connection clamps are available

On request: DALI, DIM (see ordering instructions on pg. 180)



Prema zahtjevu:
On request: DALI DIM

Art.	W	K	V	AxBxH		kg
Dulux D/E						
3132118	1x18W	3K/4K	230V	230x230x90	210x210	2,3
3132126	1x26W	3K/4K	230V	230x230x90	210x210	2,3
3132218	2x18W	3K/4K	230V	230x230x90	210x210	2,3
3132226	2x26W	3K/4K	230V	230x230x90	210x210	2,3
3142218	2x18W	3K/4K	230V	300x300x90	290x290	3,3
3142226	2x26W	3K/4K	230V	300x300x90	290x290	3,3
Dulux T/E						
3132132	1x32W	3K/4K	230V	230x230x90	210x210	2,3
3132232	2x32W	3K/4K	230V	230x230x90	210x210	2,3
3142232	2x32W	3K/4K	230V	300x300x90	290x290	3,3

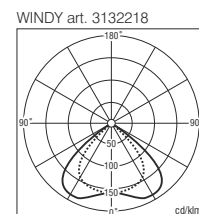
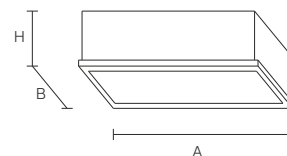

Windy

Ugradna LED svjetiljka / Recessed LED lamp

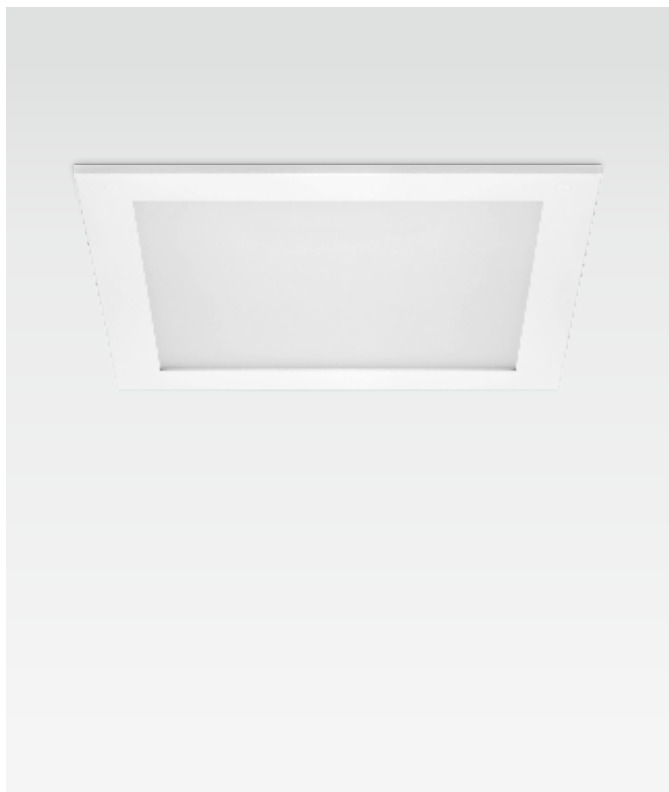

Kućište: prešani aluminij obojan termoeпокsidnom bojom

Standardna fino strukturna boja: bijela, siva, crna

Napajanje: 230V/50Hz

Električne komponente: ugrađene u kućište

Izvor svjetla: LED najnovije generacije koji omogućuju visoku efikasnost i učinkovitost CRI>80; životni vijek LED izvora min 50.000h L70B10 na $T_p=65^{\circ}\text{C}$; klasa energetske učinkovitosti A+

Difuzor: protubješteći opalni polikarbonat homogenog efekta tehnologije "Crystal Ice"

Montaža: pomoću nosača u otvor

Spajanje: demontažom difuzora dostupne su priključne stezaljke

Prema zahtjevu: panik, DALI, DIM (pogledati upute za naručivanje str. 180)

Housing: pressed aluminium covered with thermal epoxy color

Standard color: white, gray, black

Power: 230V/50Hz

Supply unit: built in the housing

Light source: LED latest generation with asymmetric flood optics that allow high efficiency and effectivity (symmetric on request) CRI>80. Lifetime of LED's 50.000h L70B10 on $T_p=65^{\circ}\text{C}$. Energy efficiency class A+

Diffuser: anti-glare opal diffuser with homogenous effect "Crystal Ice"

Mounting: with holders into opening

Connecting: through demounting the diffuser, connection clamps are available

On request: DALI, DIM (see ordering instructions on pg. 180)



Prema zahtjevu: DALI, DIM

Art.	W	K	V	lm	AxBxH		kg
LED							
3132711	13,6W	3K/4K	230V	1500/1500	230x230x90	210x210	2,3
3132712	15,3W	3K/4K	230V	2070/2250	230x230x90	210x210	2,3
3132713	23,1W	3K/4K	230V	2830/3100	230x230x90	210x210	2,3
3142721	11,3W	3K/4K	230V	1670/1730	300x300x90	290x290	2,4
3142722	20,4W	3K/4K	230V	2300/2300	300x300x90	290x290	2,5

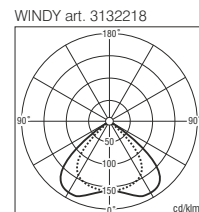
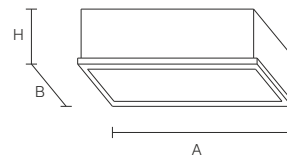



Smooth

SMOOTH inovativna serija svjetiljka bez vidljivog ruba izrađena od 100% prirodnog gipsanog kalcijevog **alabastera**, nastalog mješanjem mineralnih spojeva. Dizajniran za montažu u gipsane stropove s kojima se stapa i samim time postaje dio cjelovite površine stropova.

Arhitektonski se uklapa u sve moderne interijere a odlikuju ga sljedeće karakteristike: dekorativan, dekorira se sa bilo kojom tipologijom boje na bazi vode ili sintetike, pogodan za visoke i niske temperature, podnosi niske temperature, negoriv, bez dilatacije, analergičan, netoksičan i ekološki inovativan.

*SMOOTH an innovative line of trimless luminaires made from 100% natural gypsum calcite **alabaster**, created by mixing mineral elements.*

Designed to be mounted in plaster and thus become unified with the ceiling structure.

As an architectural material fits into all modern interiors, and it is characterized by the following characteristics: decorative, decorated with any type of water-based paints or sintetic withstands high and low temperature, submitted to the low temperature, non-combustible, without dilatation, hypoallergenic, non-toxic and environmentally friendly.

NAMJENA / USAGE



Smooth round

Ugradna Alabaster svjetiljka bez vidljivog ruba / *Recessed Alabaster trimless lamp*



Kućište: gipsani kalcijev alabaster

Standardna boja: svjetiljku je potrebno obojati zajedno sa stropom

Napajanje: 230V/50Hz

Električne komponente: odvojene napojne jedinice (napojne jedinice u kompletu)

Izvor svjetla: GU10 žarulje, LED najnovije generacije, MacAdam 4 CRI>80; LED min 50.000h L80F50 na Tp=75°C; EEI A

Montaža: pričvršćenje u gips pomoću vijaka (pribor za montažu u kompletu), te gletanjem sa strukturom stropa

Prema zahtjevu: regulacijska jedinica DALI, DIM (pogledati upute za naručivanje str. 180)

Housing: gypsum calcite alabaster

Standard color: the luminaire needs to be painted together with the ceiling
Power: 230V/50Hz

Supply unit: separate supply units (supply units included)

Light source: GU10 bulbs, LED newest generation, MacAdam 4 CRI>80; LED min 50.000h L80F50 on Tp=75°C. EEI A

Mounting: mounting in plaster ceiling using screws (installation tool in the set) and smoothing the plaster

On request: regulation unit DALI, DIM (see ordering instructions on pg. 180)



Prema zahtjevu:
On request: DALI DIM

Art.	W	K	V	lm	xH		kg
GU10							
3262050	1 x GU10	3K/4K	230V		134x130*	139	0,2
LED							
3262711	10,7W	3K/4K	230V	1100/1200	134x130	139	0,2
3262713	12,8W	3K/4K	230V	1340/1460	134x130	139	0,2

*Visina može varirati ovisno o žarulji
Height may vary depending by lamp type

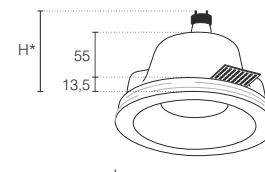

SMOOTH ROUND
art. 3262711

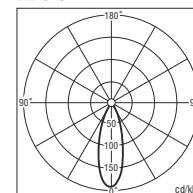

Smooth square

Ugradna Alabaster svjetiljka bez vidljivog ruba / *Recessed Alabaster trimless lamp*



Kućište: gipsani kalcijev alabaster

Standardna boja: svjetiljku je potrebno obojati zajedno sa stropom

Napajanje: 230V/50Hz

Električne komponente: odvojene napojne jedinice (napojne jedinice u kompletu)

Izvor svjetla: GU10 žarulje, LED najnovije generacije, MacAdam 4 CRI>80; LED min 50.000h L80F50 na $T_p=75^{\circ}\text{C}$; EEI A

Montaža: pričvršćenje u gips pomoću vijaka (pribor za montažu u kompletu), te gletanjem sa strukturom stropa

Prema zahtjevu: regulacijska jedinica DALI, DIM (pogledati upute za naručivanje str. 180)

Housing: gypsum calcite alabaster

Standard color: white

Power: 230V/50Hz

Supply unit: separate supply units (supply units included)

Light source: GU10 bulbs, LED newest generation, MacAdam 4 CRI>80;

LED min 50.000h L80F50 on $T_p=75^{\circ}\text{C}$. EEI A

Mounting: mounting in plaster ceiling using screws (installation tool in the set) and smoothing the plaster

On request: regulation unit DALI, DIM (see ordering instructions on pg. 180)

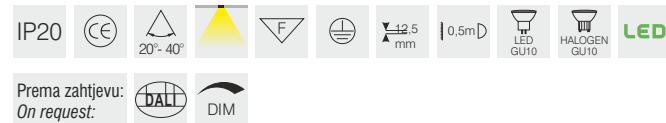

Art.	W	K	V	lm	AxAxH	kg
GU10						
3272050	1 x GU10	3K/4K	230V	115x115x120*	120x120	0,2
LED						
3272711	10,7W	3K/4K	230V	1100/1200	115x115x120	0,2
3272713	12,8W	3K/4K	230V	1340/1460	115x115x120	0,2

*Visina može varirati ovisno o žarulji
Height may vary depending by lamp type

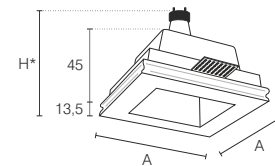

SMOOTH SQUARE
art. 3272711

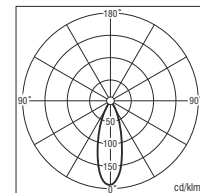

Smooth maxi

Ugradna Alabaster svjetiljka bez vidljivog ruba / *Recessed Alabaster trimless lamp*



Kućiče: gipsani kalcijev alabaster

Standardna boja: svjetiljku je potrebno obojati zajedno sa stropom

Reflektor: od 99,9% metaliziranog aluminija (osim u LED izvedbi)

Difuzor: dekorativno kaljeno staklo

Električne komponente: odvojene napojne jedinice (napojne jedinice u kompletu)

Izvor svjetla: Dulux, metal halogene HQI i LED najnovije generacije,

MacAdam 4 CRI>80; LED min 50.000h L80F50 na Tp=75°C; EEI A

Montaža: pričvršćenje u gips pomoću vijaka (pribor za montažu u kompletu), te gletanjem sa strukturom stropa

Prema zahtjevu: regulacijska jedinica DALI, DIM (pogledati upute za naručivanje str. 180)

Housing: gypsum calcite alabaster

Standard color: white

Reflector: in 99,9% metalized aluminium (except in LED variant)

Diffuser: decorative tempered glass

Supply unit: separate supply units (supply units included)

Light source: Dulux, metalhalogen HQI & LED newest generation, MacAdam 4 CRI>80; LED min 50.000h L80F50 on Tp=75°C. EEI A

Mounting: mounting in plaster ceiling using screws (installation tool in the set) and smoothing the plaster

On request: regulation unit DALI, DIM (see ordering instructions on pg. 180)

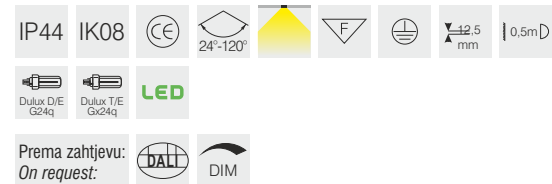

Art.	W	K	V	lm	xH	⌀	kg
DULUX D/E							
3282213	2x13,0W	3K/4K	230V	360x175	365	2,5	
3282218	2x18,0W	3K/4K	230V	360x175	365	2,5	
3282226	2x26,0W	3K/4K	230V	360x175	365	2,5	
DULUX T/E							
3282232	2x32,0W	3K/4K	230V	360x175	365	2,5	
LED							
3282701	17,3W	3K/4K	230V	1430/1560	360x175	365	2,3
3282702	21,6W	3K/4K	230V	2300/2500	360x175	365	2,3
3282703	32,1W	3K/4K	230V	3300/3600	360x175	365	2,3

Prozirno kaljeno staklo
Protective transparent glass

art. 608

Opalno kaljeno staklo
Protective opal glass

art. 609

Prozirno dekorativno staklo
Protective transparent glass

art. 610

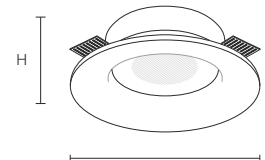

SMOOTH MAXI art. 3282701

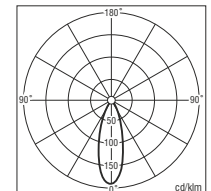

Arca

Arca linija proizvoda dizajnirana je kako bi se stopila sa stropom te nakon ugradnje nema vidljivog ruba, istovremeno svojim minimalističkim oblikom nenametljivo krasi prostor te obasjava visokom svjetlosnom efikasnošću. Veliki izbor dimenzija i oblika čini ovu seriju svjetiljaka idealnom za naglašavanje karakteristika prostora.

Arca line of products is designed to merge with ceiling and after instalation there is no visible edge, at the same time this luminaire with it's minimalistic shape unobtrusively enriches space with high effciciency illumination. Various dimensions and shapes to choose from makes this luminaire ideal for accentuatingthe chosen room characteristics.

NAMJENA / USAGE



Arca square

Ugradna svjetiljka bez vidljivog ruba / *Recessed trimless lamp*



Kućište: čelični lim obojan termoeпокsidnom finostrukturnom bijelom bojom
Električne komponente: odvojene napojne jedinice (napojne jedinice u kompletu)

Izvor svjetla: Dulux T/E, T5 žarulje i LED generacije 3, self-cooling, MacAdam 3 CRI>80; LED min 60.000h L80F50 na $T_p=65^{\circ}\text{C}$; EEI A++

Difuzor: protubljesteći opalni homogenog efekta "Crystal ice"

Montaža: pričvršćenje u gips uz pomoć vijaka (pribor za montažu u kompletu), te gletanjem sa strukturom stropa

Spajanje: skidanjem difuzora dostupne su priključne stezaljke i ostale električne komponente

Prema zahtjevu: panik, reg. jedinica DALI, DIM (vidi upute za naručivanje str. 180)

Housing: steel sheet-metal covered with thermal epoxy finely-textured white color

Supply unit: separate supply units (supply units included)

Light source: Dulux T/E, T5 bulbs & LED generation 3, self-cooling; MacAdam 3 CRI>80; LED min 60.000h L80F50 on $T_p=65^{\circ}\text{C}$. EEI A++

Diffuser: anti-glare opal with homogenous effect "Crystal ice"

Mounting: with holders for plaster (installation tool in set), smoothing the plaster

Connecting: through removing the diffuser, connection clamps and all other electronic components are available

On request: emergency light, reg. unit DALI, DIM (see ordering instructions on pg. 180)

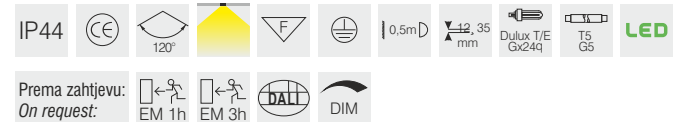

Art.	W	K	V	lm	A x A x H	kg
DULUX T/E						
3292218	2x18W	3K/4K	230V		220x220x95 230x230	2,1
3292226	2x26W	3K/4K	230V		220x220x95 230x230	2,3
3292232	2x32W	3K/4K	230V		220x220x95 230x230	4,0
T5						
3292414	4x14W	3K/4K	230V		600x600x95 610x610	10,0
3292424	4x24W	3K/4K	230V		600x600x95 610x610	10,0
LED						
3292701	17,7W	3K/4K	230V	1980/1980	160x160x95 170x170	2,0
3292702	22,1W	3K/4K	230V	2480/2480	160x160x95 170x170	2,1
3292703	15,3W	3K/4K	230V	2070/2250	220x220x95 230x230	2,1
3292705	23,1W	3K/4K	230V	2830/3100	220x220x95 230x230	2,3
3292706	34,1W	3K/4K	230V	4600/5020	400x400x95 410x410	5,3
3292707	48,3W	3K/4K	230V	6515/7080	400x400x95 410x410	5,4
3292741	31,2W	3K/4K	230V	4840/5000	600x600x95 610x610	10,0
3292742	38,0W	3K/4K	230V	5720/5920	600x600x95 610x610	10,1
3292743	45,2W	3K/4K	230V	6680/6920	600x600x95 610x610	10,2

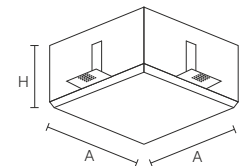

ARCA SQUARE art. 3292218

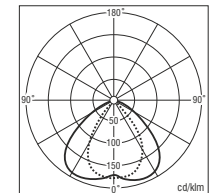



PROJECT: Hotel Punta
PHOTOGRAPHER: Eltor

Arca square up

Ugradna svjetiljka bez vidljivog ruba s uvučenim difuzorom / Recessed trimless lamp with retracted diffuser



Kućište: čelični lim obojan termoeпокsidnom finostrukturnom bijelom bojom

El. komponente: odvojene napojne jedinice (napojne jedinice u kompletu)

Izvor svjetla: Dulux T/E, T5 žarulje i LED generacije 3, self-cooling, MacAdam 3 CRI>80; LED min 60.000h L80F50 na Tp=65°C; EEI A++

Difuzor: protublješteći opalni homogenog efekta "Crystal ice"

Montaža: pričvršćenje u gips uz pomoć vijaka (pribor za montažu u kompletu), te gletanjem sa strukturom stropa

Spajanje: skidanjem difuzora dostupne su priključne stezaljke i ostale električne komponente

Prema zahtjevu: panik, reg. jedinica DALI, DIM (vidi upute za naručivanje str. 180)

Housing: steel sheet-metal covered with thermal epoxy finely-textured white colour

Supply unit: separate supply units (supply units included)

Light source: Dulux T/E, T5 bulbs & LED generation 3, self-cooling; MacAdam 3 CRI>80; LED min 60.000h L80F50 on Tp=65°C; EEI A++

Diffuser: anti-glare opal with homogenous effect "Crystal ice"

Mounting: with holders for plaster (installation tool in the set), smoothing the plaster

Connecting: through removing the diffuser, connection clamps and all other electronic components are available

On request: emergency light, reg. unit DALI, DIM (see ordering instructions on pg. 180)

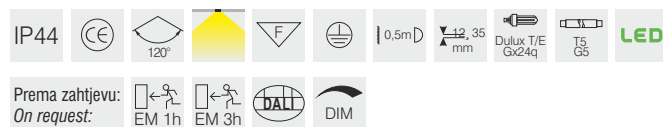

Art.	W	K	V	lm	A x H	kg
DULUX T/E						
3302218	2x18W	3K/4K	230V	220x220x135	230x230	2,7
3302226	2x26W	3K/4K	230V	220x220x135	230x230	2,9
3302232	2x32W	3K/4K	230V	220x220x135	230x230	4,7
T5						
3302414	4x14W	3K/4K	230V	600x600x135	610x610	10,8
3302424	4x24W	3K/4K	230V	600x600x135	610x610	10,9
LED						
3302701	17,7W	3K/4K	230V	1980/1980	160x160x135	2,2
3302702	22,1W	3K/4K	230V	2480/2480	160x160x135	2,3
3302703	15,3W	3K/4K	230V	2070/2250	220x220x135	2,3
3302705	23,1W	3K/4K	230V	2830/3100	220x220x135	2,5
3302706	34,1W	3K/4K	230V	4600/5020	400x400x135	5,5
3302707	48,3W	3K/4K	230V	6515/7080	400x400x135	5,6
3302741	31,2W	3K/4K	230V	4840/5000	600x600x135	10,2
3302742	38,0W	3K/4K	230V	5720/5920	600x600x135	10,3
3302743	45,2W	3K/4K	230V	6680/6920	600x600x135	10,5

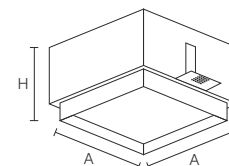

ARCA SQUARE UP
art. 3302218

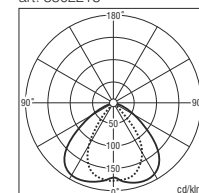

Arca rectangle

Ugradna svjetiljka bez vidljivog ruba / Recessed trimless lamp



Kućište: čelični lim obojan, termoeпокsidnom finostrukturnom bijelom bojom
Električne komponente: odvojene napojne jedinice (napojne jedinice u kompletu)

Izvor svjetla: T5 žarulje, LED generacije 3, self-cooling, MacAdam 3 CRI>80; LED min 60.000h L80F50 na $T_p=65^{\circ}\text{C}$; EEI A++

Difuzor: protublješteći opalni homogenog efekta "Crystal ice"

Montaža: pričvršćenje u gips uz pomoć vijaka (pribor za montažu u kompletu), te gletanjem sa strukturom stropa

Spajanje: skidanjem difuzora dostupne su priključne stezaljke i ostale električne komponente

Prema zahtjevu: panik, regulacijska jedinica DALI, DIM (vidi upute za naručivanje str. 180)

Housing: steel sheet-metal covered with thermal epoxy finely-textured white colour

Supply unit: separate supply units (supply units included)

Light source: Dulux D/E, T/E bulbs, LED generation 3, self-cooling; MacAdam 3 CRI>80; LED min 60.000h L80F50 on $T_p=65^{\circ}\text{C}$. EEI A++

Difuser: anti-glare opal with homogenous effect "Crystal ice"

Mounting: with holders for plaster (installation tool in the set), smoothing the plaster

Connecting: through removing the diffuser, connection clamps and all other electronic components are available

On request: emergency light, regulation unit DALI, DIM (see ordering instructions on pg. 180)



Prema zahtjevu: EM 1h, EM 3h, DALI, DIM

Art.	W	K	V	lm	A x B x H	kg
T5						
3492214	2x14W	3K/4K	230V	600x170x95	610x180	9,1
3492224	2x24W	3K/4K	230V	600x170x95	610x180	9,1
3492221	2x21W	3K/4K	230V	900x170x95	910x180	9,4
3492239	2x39W	3K/4K	230V	900x170x95	910x180	9,4
3492228	2x28W	3K/4K	230V	1200x170x95	1210x180	10,8
3492254	2x54W	3K/4K	230V	1200x170x95	1210x180	11,0
3492235	2x35W	3K/4K	230V	1500x170x95	1510x180	12,9
3492249	2x49W	3K/4K	230V	1500x170x95	1510x180	12,7
3492280	2x80W	3K/4K	230V	1500x170x95	1510x180	13,0
LED						
3492712	25,0W	3K/4K	230V	3360/3480	600x170x95	7,2
3492723	50,0W	3K/4K	230V	6960/7160	1200x170x95	8,9
3492724	63,0W	3K/4K	230V	9080/9360	1200x170x95	9,0
3492733	62,0W	3K/4K	230V	8700/8960	1500x170x95	10,9
3492734	78,0W	3K/4K	230V	11340/11700	1500x170x95	11,1

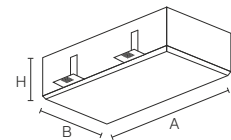

ARCA RECTANGLE
art. 3492214

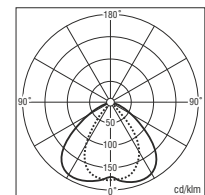

Arca rectangle slim

Ugradna svjetiljka bez vidljivog ruba / *Recessed trimless lamp*

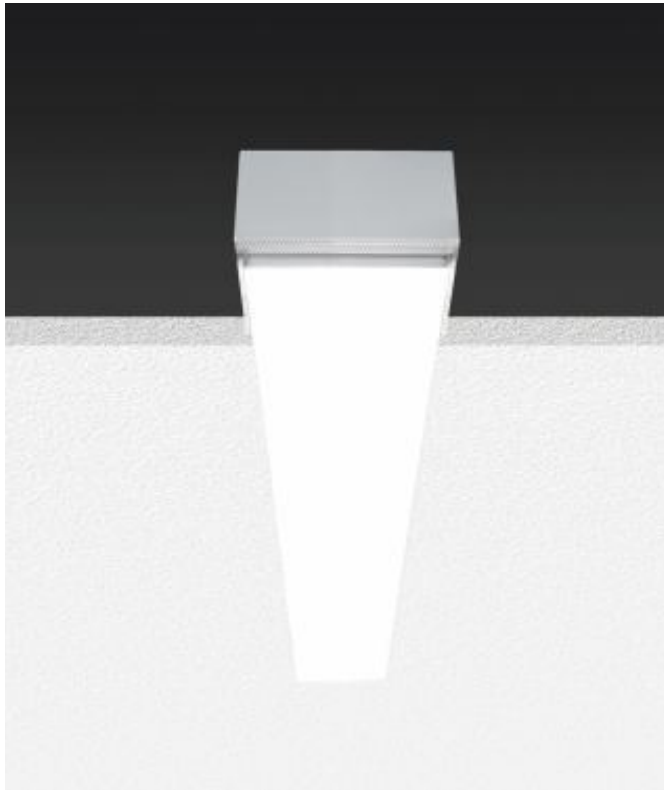

Kućište: čelični lim obojan, termoeпокsidnom finostrukturnom bijelom bojom

Električne komponente: odvojene napojne jedinice (napojne jedinice u kompletu)

Izvor svjetla: T5 žarulje, LED generacije 3, self-cooling, MacAdam 3 CRI>80; LED min 60.000h L80F50 na $T_p=65^{\circ}\text{C}$; EEI A++

Difuzor: protubljesteći opalni difuzor homogenog efekta "Crystal ice"

Montaža: pričvršćenje u gips uz pomoć vijaka (pribor za montažu u kompletu), te gletanjem sa strukturom stropa

Spajanje: skidanjem difuzora dostupne su priključne stezaljke i ostale električne komponente

Prema zahtjevu: panik, regulacijska jedinica DALI, DIM (vidi upute za naručivanje str. 180)

Housing: steel sheet-metal covered with thermal epoxy finely-textured white colour

Supply unit: separate supply units (supply units included)

Light source: Dulux D/E, T/E bulbs, LED generation 3, self-cooling;

MacAdam 3 CRI>80; LED min 60.000h L80F50 on $T_p=65^{\circ}\text{C}$. EEI A++





Diffuser: anti-glare opal diffuser with homogenous effect "Crystal ice"

Mounting: with holders for plaster (installation tool in the set), smoothing the plaster

Connecting: through removing the diffuser, connection clamps and all other electronic components are available

On request: emergency light, regulation unit DALI, DIM (see ordering instructions on pg. 180)



Prema zahtjevu:     

On request:

Art.	W	K	V	lm	A x B x H		kg
T5							
3492114	1x14W	3K/4K	230V		600x100x95	610x110	5,1
3492124	1x24W	3K/4K	230V		600x100x95	610x110	5,1
3492121	1x21W	3K/4K	230V		900x100x95	910x110	5,4
3492139	1x39W	3K/4K	230V		900x100x95	910x110	5,4
3492128	1x28W	3K/4K	230V		1200x100x95	1210x110	7,8
3492154	1x54W	3K/4K	230V		1200x100x95	1210x110	8,0
3492135	1x35W	3K/4K	230V		1500x100x95	1510x110	8,9
3492149	1x49W	3K/4K	230V		1500x100x95	1510x110	8,7
3492180	1x80W	3K/4K	230V		1500x100x95	1510x110	9,0
LED							
3492711	12,4W	3K/4K	230V	1680/1740	600x100x95	610x110	5,1
3492721	25,0W	3K/4K	230V	3480/3580	1200x100x95	1210x110	6,8
3492722	39,0W	3K/4K	230V	5280/5460	1200x100x95	1210x110	6,9
3492731	31,0W	3K/4K	230V	4350/4480	1500x100x95	1510x110	8,8
3492732	48,0W	3K/4K	230V	6600/6820	1500x100x95	1510x110	8,6

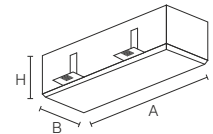

ARCA RECTANGLE SLIM
art. 3292114

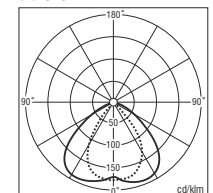

Arca round

Ugradna svjetiljka bez vidljivog ruba / Recessed trimless lamp



Kućište: čelični lim obojan, termoeпокsidnom bijelom bojom
termoeпокsidnom bijelom bojom

Električne komponente: odvojene napojne jedinice (napojne jedinice u kompletu)

Izvor svjetla: fluo T5 FC i Dulux T/E žarulje, LED generacije 3, self-cooling, MacAdam 3 CRI>80; LED min 60.000h L80F50 na Tp=65°C; EEI A++

Difuzor: protublješteći opalni difuzor homogenog efekta "Crystal ice"

Montaža: nosačima za gips (pribor za montažu u kompletu), gletanje u gips

Spajanje: skidanjem difuzora dostupne su priključne stezaljke i ostale električne komponente

Prema zahtjevu: panik, regulacijska jedinica DALI, DIM (vidi upute za naručivanje str. 180)

Housing: steel sheet-metal covered with thermal epoxy white colour

Supply unit: separate supply units (supply units included)

Light source: fluo T5 FC and Dulux T/E bulbs, LED generation 3, self-cooling; MacAdam 3 CRI>80; LED min 60.000h L80F50 on Tp=65°C. EEI A++

Diffuser: anti-glare opal diffuser with homogenous effect "Crystal ice"

Mounting: with holders for plaster (installation tool in the set), smoothing the plaster

Connecting: through removing the diffuser, connection clamps and all other electronic components are available

On request: emergency light, regulation unit DALI, DIM (see ordering instructions on pg. 180)



Prema zahtjevu:
On request:



Art.	W	K	V	lm	x H	∅	kg
Dulux T/E							
3312218	2x18W	3K/4K	230V		265x95	273	2,1
3312226	2x26W	3K/4K	230V		265x95	273	2,1
3312232	2x32W	3K/4K	230V		265x95	273	2,1
T5 FC							
3312022	22W	3K/4K	230V		265x95	273	2,1
3312040	40W	3K/4K	230V		395x95	403	2,1
3312055	55W	3K/4K	230V		395x95	403	2,1
LED							
3312710	17,7W	3K/4K	230V	1980/1980	135x70	165	0,8
3312713	22,1W	3K/4K	230V	2480/2480	135x70	165	0,8
3312703	15,3W	3K/4K	230V	2070/2250	265x95	273	2,0
3312704	20,4W	3K/4K	230V	2500/2500	265x95	273	2,0
3312706	23,1W	3K/4K	230V	2830/3100	265x95	273	2,0

Slični proizvodi
Related products:



ANTIGONE
Str. 17

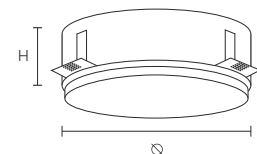

ARCA ROUND art. 3312218

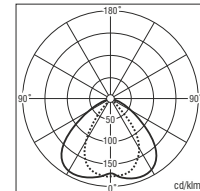

Arca round up

Ugradna svjetiljka bez vidljivog ruba / *Recessed trimless lamp*



Kućište: čelični lim obojan, termoeпокsidnom bijelom bojom
termoeпокsidnom bijelom bojom

Električne komponente: odvojene napojne jedinice (napojne jedinice u kompletu)

Izvor svjetla: fluo T5 FC i Dulux T/E žarulje, LED generacije 3, self-cooling, MacAdam 3 CRI>80; LED min 60.000h L80F50 na Tp=65°C; EEI A++

Difuzor: protublješteći opalni difuzor homogenog efekta "Crystal ice"

Montaža: nosačima za gips (pribor za montažu u kompletu), gletanje u gips

Spajanje: skidanjem difuzora dostupne su priključne stezaljke i ostale električne komponente

Prema zahtjevu: panik, regulacijska jedinica DALI, DIM (vidi upute za naručivanje str. 180)

Housing: steel sheet-metal covered with thermal epoxy white colour

Supply unit: separate supply units (supply units included)

Light source: fluo T5 FC and Dulux T/E bulbs, LED generation 3, self-cooling; MacAdam 3 CRI>80; LED min 60.000h L80F50 on Tp=65°C. EEI A++

Diffuser: anti-glare opal diffuser with homogenous effect "Crystal ice"

Mounting: with holders for plaster (installation tool in the set), smoothing the plaster

Connecting: through removing the diffuser, connection clamps and all other electronic components are available

On request: emergency light, regulation unit DALI, DIM (see ordering instructions on pg. 180)



Prema zahtjevu:
On request:

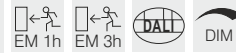

Art.	W	K	V	lm	x H	∅	kg
T5 FC							
3322122	22W	3K/4K	230V		265x135	273	2,2
3322140	40W	3K/4K	230V		395x135	403	3,3
3322155	55W	3K/4K	230V		395x135	403	3,3
Dulux T/E							
3322218	2x18W	3K/4K	230V		265x135	273	2,2
3322226	2x26W	3K/4K	230V		265x135	273	2,2
3322232	2x32W	3K/4K	230V		265x135	273	2,2
LED							
3322703	15,3W	3K/4K	230V	2070/2250	265x135	273	2,1
3322704	20,4W	3K/4K	230V	2500/2500	265x135	273	2,1
3322705	23,1W	3K/4K	230V	2830/3100	265x135	273	2,1

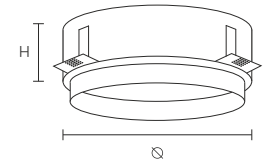

ARCA ROUND UP
art. 3322218

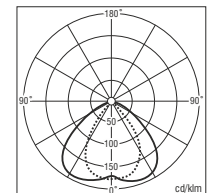

Plain

Elegancija, jednostavan dizajn i sloboda kreiranja svjetlosti, odlika su i najznačajnije karakteristike svjetiljki Plain, bez obzira na ugradnu, nadgradnu ili viseću verziju.

Kućište iz ekstrudiranog, anodiziranog aluminijskog profila sa opalnim polikarbonatnim difuzorom. Elegantnog i jednostavnog dizajna PLAIN rasvjetna tijela oplemenjuju stambene, poslovne, hotelske i ostale prostore.

Elegance, easy design and lighting creating freedom are the best significant of Plain lighting armatures, irrespective if they are integrated, recessed or suspended version.

The body is made of extruded aluminium profile with anodised finishing, complete with opal polycarbonate diffuser. With elegance and simple desing PLAIN luminaires enrich living spaces, offices and hotels.

NAMJENA / USAGE



Plain

Nadgradna/viseća svjetiljka sa difuzorom • *Surface/suspended lamp with diffuser*



BIJELA/WHITE (W)



ANODIZED AL. (A)



CRNA/BLACK (B)

Kućište: ekstrudirani aluminijski profil

Standardna boja: bijela, anodizirani aluminij, crna finostrukturna

Napajanje: 230V/50Hz

Električne komponente: ugrađene u kućište

Izvor svjetla: Fluo T5 cijev

Difuzor: protublješteći opalni polikarbonat homogenog efekta tehnologije "Crystal Ice"

Montaža: vijcima na strop / vješanje na čelične visilice

Spajanje: skidanjem difuzora dostupne su priključne stezaljke i ostale električne komponente

Prema zahtjevu: regulacijska jedinica DALI, DIM - samo u visećoj varijanti (vidi upute za naručivanje str. 180)

Housing: extruded aluminium profile

Standard color: white, anodized aluminium, black finely textured

Power: 230V/50Hz

Supply unit: built in the housing

Light source: fluo T5 tube 20,000h

Diffuser: anti-glare opal diffuser with homogenous effect "Crystal Ice"

Mounting: with screws to the ceiling / hanging on steel suspension wires

Connecting: by demounting the diffuser, connection clamps and all other electronic components are available

On request: regulation unit DALI, DIM - only for suspended version (see ordering instructions on pg. 180)



Prema zahtjevu:
On request: DALI, DIM

Art.	W	K	V	AxBxH	kg
T5					
2401114	1x14W	3K/4K	230V	583x43x48	0,7
2401124	1x24W	3K/4K	230V	583x43x48	0,7
2401121	1x21W	3K/4K	230V	883x43x48	0,9
2401139	1x39W	3K/4K	230V	883x43x48	0,9
2401128	1x28W	3K/4K	230V	1183x43x48	1,2
2401154	1x54W	3K/4K	230V	1183x43x48	1,2
2401135	1x35W	3K/4K	230V	1483x43x48	1,4
2401149	1x49W	3K/4K	230V	1483x43x48	1,4



Sajla za vješanje s autoblock sistemom L=1500mm
Hanging wire with autoblock system l=1500mm

art. 296



Ukrasna rozeta s prozirnim dekorativnim kabelom L=1500mm
Decorative box with decorative transparent cable L=1500mm

art. 297

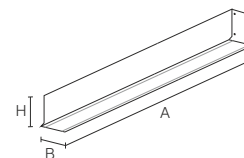

Slični proizvodi

Related products:

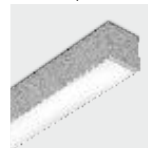

LS 50
Str. 138

PLAIN art. 2401114

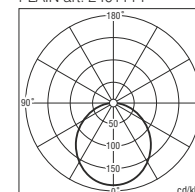

Plain

Nadgradna/viseća LED svjetiljka sa difuzorom / Surface/suspended LED lamp with diffuser



BIJELA/WHITE (W)



ANODIZED AL. (A)



CRNA/BLACK (B)

Kućište: ekstrudirani aluminijski profil

Standardna boja: bijela, anodizirani aluminij, crna finostrukturna

Napajanje: 230V/50Hz

Električne komponente: ugrađene u/na kućište

Izvor svjetla: LED najnovije generacije, MacAdam 3 CRI>80; LED min 60.000h L80F50 na $T_p=65^\circ\text{C}$; EEL A++

Difuzor: protubliješćeci opalni polikarbonat homogenog efekta tehnologije "Crystal Ice"

Montaža: vijcima na strop / vješanje na čelične visilice

Spajanje: demontažom difuzora dostupne su priključne stezaljke

Prema zahtjevu: regulacijska jedinica DALI, DIM - samo u visećoj varijanti (vidi upute za naručivanje str. 180)

Housing: extruded aluminium profile

Standard color: white, anodized aluminium, black finely textured

Power: 230V/50Hz

Supply unit: built in/on the housing

Light source: LED newest generation, MacAdam 3 CRI>80; LED min 60.000h L80F50 on $T_p=65^\circ\text{C}$. EEL A++

Diffuser: anti-glare opal diffuser with homogenous effect "Crystal Ice"

Mounting: with screws to the ceiling / hanging on steel suspension wires

Connecting: through demounting the diffuser, connection clamps are available

On request: regulation unit DALI, DIM - only for suspended version (see ordering instructions on pg. 180)

IP44 IK07

Prema zahtjevu:
On request:

Art.	W	K	V	lm	A x B x H	kg
LED						
2401706	6,20W	3K/4K	230V	820/840	322x43x48	0,7
2401713	12,4W	3K/4K	230V	1680/1740	602x43x48	0,9
2401719	18,6W	3K/4K	230V	2520/2610	882x43x48	0,9
2401725	24,8W	3K/4K	230V	3360/3480	1162x43x48	1,2
2401731	31,0W	3K/4K	230V	4200/4350	1442x43x48	1,2
2401737	37,2W	3K/4K	230V	5040/5220	1722x43x48	1,4



Sajla za vješanje s autoblock sistemom L=1500mm
Hanging wire with autoblock system L=1500mm

art. 296



Ukrasna rozeta s prozirnim dekorativnim kabelom L=1500mm
Decorative box with decorative transparent cable L=1500mm

art. 297

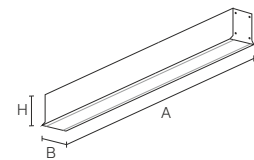

Slični proizvodi
Related products:

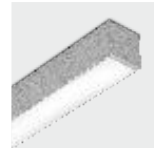

LS 50 LED
Str. 139

PLAIN art. 2402712

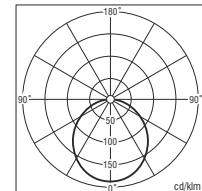



Plain recessed

Ugradna svjetiljka sa difuzorom / Recessed lamp with diffuser



BIJELA/WHITE (W)

ANODIZED AL. (A)

CRNA/BLACK (B)

Art.	W	K	V	AxBxH		kg
T5						
2402114	1x14W	3K/4K	230V	593x43x48	585x38	0,7
2402124	1x24W	3K/4K	230V	593x43x48	585x38	0,7
2402121	1x21W	3K/4K	230V	893x43x48	885x38	0,9
2402139	1x39W	3K/4K	230V	893x43x48	885x38	0,9
2402128	1x28W	3K/4K	230V	1193x43x48	1185x38	1,2
2402154	1x54W	3K/4K	230V	1193x43x48	1185x38	1,2
2402135	1x35W	3K/4K	230V	1493x43x48	1485x38	1,4
2402149	1x49W	3K/4K	230V	1493x43x48	1485x38	1,4

Kućište: ekstrudirani aluminijski profil

Standardna boja: bijela, anodizirani aluminiij, crna finostrukturna

Napajanje: 230V/50Hz

Električne komponente: odvojene napojne jedinice (napojne jedinice u kompletu)

Izvor svjetla: Fluo T5 cijev

Difuzor: protublješteći opalni polikarbonat homogenog efekta tehnologije "Crystal Ice"

Montaža: oprugama u otvor gipsanog spušenog stropa ili ugradnja u kutiju za montažu u betonskom stropu

Spajanje: demontažom difuzora dostupne su priključne stezaljke

Prema zahtjevu: panik, regulacijska jedinica DALI, DIM (vidi upute za naručivanje str. 180)

Housing: extruded aluminium profile

Standard color: white, anodized aluminium, black finely textured

Power: 230V/50Hz

Supply unit: separate supply units (supply units included)

Light source: fluo T5 tube

Diffuser: anti-glare opal diffuser with homogenous effect "Crystal Ice"

Mounting: with springs into mounting hole at suspended plaster ceiling or inserting at mounting box for mounting at concrete ceiling

Connecting: through demounting the diffuser, connection clamps are available

On request: emergency module, regulation unit DALI, DIM (see ordering instructions on pg. 180)



Prema zahtjevu: EM 1h EM 3h DALI DIM



Ugradna kutija za montažu u beton
Integrated box for installation into concrete
art.101 - Plain 14/24W
art.102 - Plain 21/39W
art.103 - Plain 28/54W
art.104 - Plain 35/49W

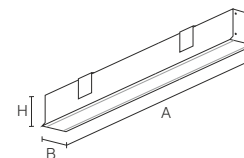

PLAIN art. 2402114

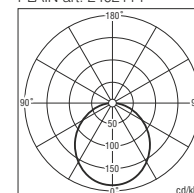

Plain recessed

Ugradna LED svjetiljka sa difuzorom / Recessed LED lamp with diffuser



BIJELA/WHITE (W)



ANODIZED AL. (A)



CRNA/BLACK (B)

Kućiče: ekstrudirani aluminijski profil

Standardna boja: bijela, anodizirani aluminij, crna finostrukturna

Napajanje: 230V/50Hz

Električne komponente: odvojene napojne jedinice (napojne jedinice u kompletu)

Izvor svjetla: LED najnovije generacije, MacAdam 3 CRI>80; LED min 60.000h L80F50 na $T_p=65^{\circ}\text{C}$; EEI A++

Difuzor: protublješteći opalni polikarbonat homogenog efekta tehnologije "Crystal Ice"

Montaža: oprugama u otvor gipsanog spušenog stropa ili ugradnja u kutiju za montažu u betonskom stropu

Spajanje: demontažom difuzora dostupne su priključne stezaljke

Prema zahtjevu: panik, regulacijska jedinica DALI, DIM (vidi upute za naručivanje str. 180)

Housing: extruded aluminium profile

Standard color: white, anodized aluminium, black finely textured

Power: 230V/50Hz

Supply unit: separate supply units (supply units included)

Light source: LED newest generation, MacAdam 3 CRI>80; LED min 60.000h L80F50 on $T_p=65^{\circ}\text{C}$. EEI A++

Diffuser: anti-glare opal diffuser with homogenous effect "Crystal Ice"

Mounting: with springs into mounting hole at suspended plaster ceiling or inserting at mounting box for mounting at concrete ceiling

Connecting: through demounting the diffuser, connection clamps are available

On request: emergency module, regulation unit DALI, DIM (see ordering instructions on pg. 180)



Prema zahtjevu:
On request:

Art.	W	K	V	lm	A x B xH		kg
LED							
2402706	6,20W	3K/4K	230V	820/840	332x43x48	324x38	0,5
2402713	12,4W	3K/4K	230V	1680/1740	612x43x48	604x38	0,8
2402712	19,3W	3K/4K	230V	2720/2810	612x43x48	604x38	0,8
2402719	18,6W	3K/4K	230V	2520/2610	892x43x48	884x38	0,9
2402722	28,9W	3K/4K	230V	4080/4210	892x43x48	884x38	0,9
2402725	24,8W	3K/4K	230V	3360/3480	1172x43x48	1165x38	1,3
2402732	38,6W	3K/4K	230V	5280/5460	1172x43x48	1165x38	1,3
2402731	31,0W	3K/4K	230V	4200/4350	1452x43x48	1444x38	1,5
2402742	48,2W	3K/4K	230V	6800/7020	1452x43x48	1444x38	1,5
2402737	37,2W	3K/4K	230V	5040/5220	1732x43x48	1724x38	1,8



Ugradna kutija za montažu u beton
Integrated box for installation into concrete
art.140 - Plain L=332mm
art.141 - Plain L=612mm
art.142 - Plain L=892mm
art.143 - Plain L=1172mm
art.144 - Plain L=1452mm
art.145 - Plain L=1732mm

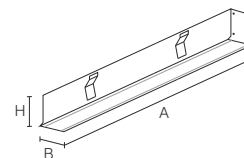

PLAIN art. 2402712

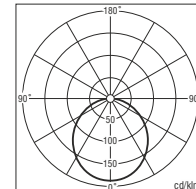

LS 50

Arhitektura i rasvjeta izražavaju kvalitetu kako našeg životnog prostora tako i naš radni okoliš.

U prostoru gdje se dešavaju neprestane promjene, visoka dinamika, statični koncepti unutrašnje opreme i rasvjete nisu usklađeni. Traže se promjene, fleksibilnost i dinamika što se odnosi i na rasvjetu, koja će poštivati različite namjene upotrebe i usklađenje sa dnevnim svjetlom. LS 50 nudi sistem rasvjete koji idealno ispunjava i najzahtjevnije prostorne karakteristike

Architecture and lighting express the quality of both our living space and working environment.

In an interior where constant changes take place, high dynamics and static concepts of interior equipment and lighting are not in harmony. Changes, flexibility and dynamics are wanted and that is relate to the lighting, which should respect different uses and harmony with daylight. LS 50 offers a lighting system that perfectly meets even the most demanding interior characteristics

NAMJENA / USAGE



Ls 50

Nadgradna/viseća svjetiljka sa difuzorom • *Surface/suspended lamp with diffuser*



BIJELA/WHITE (W)



ANODIZED AL. (A)



CRNA/BLACK (B)

Kućište: ekstrudirani aluminijski profil

Standardna boja: bijela, anodizirani aluminij, crna finostrukturna

Napajanje: 230V/50Hz

Električne komponente: ugrađene u kućište

Izvor svjetla: Fluo T5 cijev

Difuzor: protublješteći opalni polikarbonat homogenog efekta tehnologije "Crystal Ice"

Montaža: vijcima na strop / vješanje na čelične visilice

Spajanje: skidanjem difuzora dostupne su priključne stezaljke i ostale električne komponente

Prema zahtjevu: regulacijska jedinica DALI, DIM (vidi upute za naručivanje str. 180)

Housing: extruded aluminium profile

Standard color: white, anodized aluminium, black finely textured

Power: 230V/50Hz

Supply unit: built in the housing

Light source: fluo T5 tube

Diffuser: anti-glare opal diffuser with homogenous effect "Crystal Ice"

Mounting: with screws to the ceiling / hanging on steel suspension wires

Connecting: by demounting the diffuser, connection clamps and all other electronic components are available

On request: regulation unit DALI, DIM (see ordering instructions on pg. 180)



Prema zahtjevu:
On request:



Art.	W	K	V	AxBxH	kg
T5					
2141114	1x14W	3K/4K	230V	583x50x50	0,7
2141124	1x24W	3K/4K	230V	583x50x50	0,7
2141121	1x21W	3K/4K	230V	883x50x50	0,9
2141139	1x39W	3K/4K	230V	883x50x50	0,9
2141128	1x28W	3K/4K	230V	1183x50x50	1,2
2141154	1x54W	3K/4K	230V	1183x50x50	1,2
2141135	1x35W	3K/4K	230V	1483x50x50	1,4
2141149	1x49W	3K/4K	230V	1483x50x50	1,4



Sajla za vješanje s autoblock sistemom L=1500mm
Hanging wire with autoblock system L=1500mm
art. 296



Ukрасna rozeta s prozirnim dekorativnim kabelom L=1500mm
Decorative box with decorative transparent cable L=1500mm
art. 297

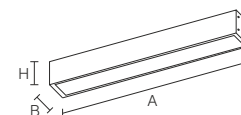

Slični proizvodi
Related products:



PLAIN
Str. 132

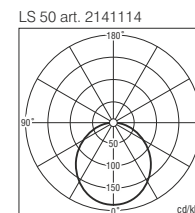

Ls 50

Nadgradna/viseća LED svjetiljka sa difuzorom • Surface/suspended LED lamp with diffuser

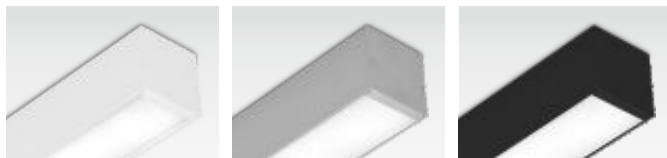
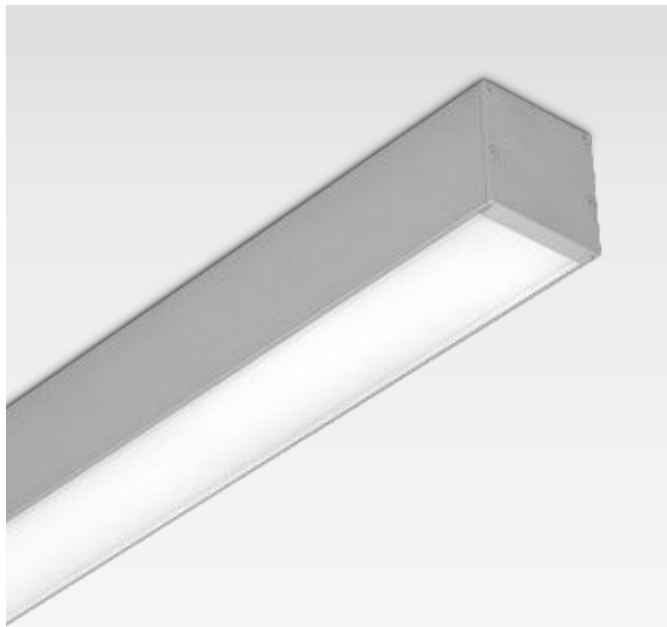

BIJELA/WHITE (W)

ANODIZED AL. (A)

CRNA/BLACK (B)

Art.	W	K	V	lm	AxBxH	kg
LED						
2141711	12,4W	3K/4K	230V	1680/1740	583x50x50	0,8
2141712	19,3W	3K/4K	230V	2720/2810	583x50x50	0,8
2141721	18,6W	3K/4K	230V	2520/2610	883x50x50	0,9
2141722	28,9W	3K/4K	230V	4080/4210	883x50x50	0,9
2141731	24,8W	3K/4K	230V	3360/3480	1183x50x50	1,3
2141732	38,6W	3K/4K	230V	5280/5460	1183x50x50	1,3
2141741	31,0W	3K/4K	230V	4200/4350	1483x50x50	1,5
2141742	48,2W	3K/4K	230V	6800/7020	1483x50x50	1,5

Kućište: ekstrudirani aluminijski profil
Standardna boja: bijela, anodizirani aluminiij, crna finostrukturna
Napajanje: 230V/50Hz
Električne komponente: ugrađene u kućište
Izvor svjetla: LED najnovije generacije, MacAdam 3 CRI>80; LED min 60.000h L80F50 na $T_p=65^{\circ}\text{C}$; EEL A++
Difuzor: protubliješćeci opalni polikarbonat homogenog efekta tehnologije "Crystal Ice"
Montaža: vijcima na strop / vješanje na čelične visilice
Spajanje: skidanjem difuzora dostupne su priključne stezaljke i ostale električne komponente
Prema zahtjevu: panik, regulacijska jedinica DALI, DIM (vidi upute za naručivanje str. 180)

Housing: extruded aluminium profile
Standard color: white, anodized aluminium, black finely textured
Power: 230V/50Hz
Supply unit: built in the housing
Light source: LED newest generation, MacAdam 3 CRI>80; LED min 60.000h L80F50 on $T_p=65^{\circ}\text{C}$. EEL A++
Diffuser: anti-glare opal diffuser with homogenous effect "Crystal Ice"
Mounting: with screws to the ceiling / hanging on steel suspension wires
Connecting: by demounting the diffuser, connection clamps and all other electronic components are available
On request: emergency module, regulation unit DALI, DIM (see ordering instructions on pg. 180)

IP44 IK07

Prema zahtjevu: EM 1h EM 3h DALI DIM

On request:

Sajla za vješanje s autoblock sistemom L=1500mm
 Hanging wire with autoblock system L=1500mm
art. 296

Ukrasna rozeta s prozirnim dekorativnim kabelom L=1500mm
 Decorative box with decorative transparent cable L=1500mm
art. 297

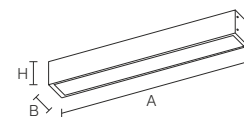

Slični proizvodi
 Related products:



PLAIN LED
 Str. 133

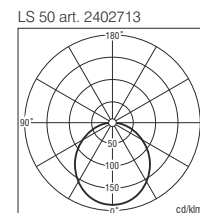



Side

Seriya svjetiljaka Side osmišljena je kako bi se svojim dizajnom i izgledom uklapala u sve moderne i arhitektonski minimalistički dizajnirane interijere ali isto tako i u zahtjevnije i bogatije prostore. To se postiže velikom prilagodljivošću samog izgleda svjetiljke, njezine dužine, tipa ali i vrlo specifičnog i dizajnerski neutralnog "rigiranog" profila.

Svjetiljke dolaze u standardnoj fluo i LED izvedbi a montaža je izuzetno jednostavna kod nadgradne ali i viseće izvedbe.

Side luminaire line is conceived to complement every modern and architecturally minimalistic interior and at the same time designed to complement more demanding and rich interiors.

This is achieved with great customizability of the luminaire, it's length, type and very specific and neutrally designed "rigged" profile.

Luminaires are available in standard fluo and LED variant and the mounting is very simple in surface mounted variant as well as in pendant variant.

NAMJENA / USAGE



Side

Nadgradna/viseća svjetiljka / *Surface mounted/suspended lamp*

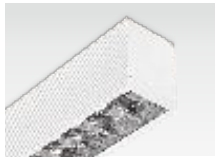
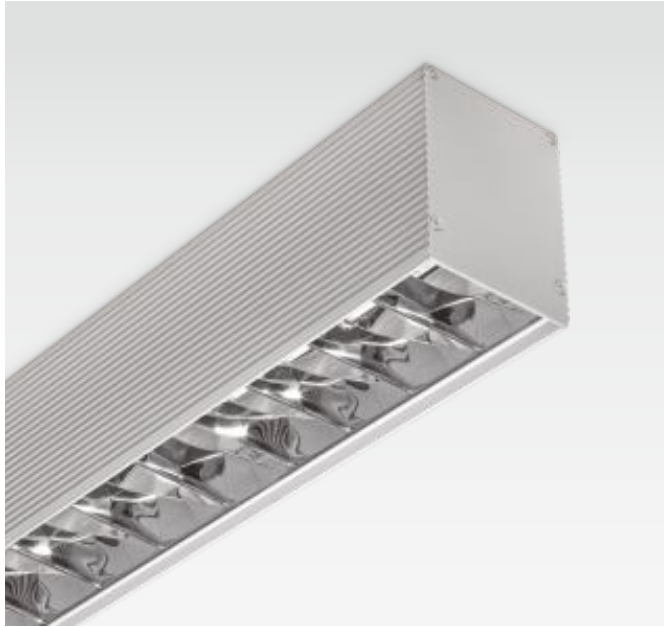

BIJELA/WHITE (W)

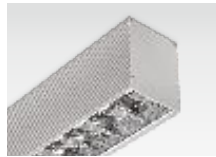

ANODIZED AL. (A)

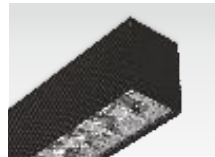

CRNA/BLACK (B)

Kućište: ekstrudirani aluminijski profil

Standardna boja: bijela, anodizirani aluminij, crna finostrukturna

Napajanje: 230V/50Hz

Električne komponente: ugrađene u kućište

Izvor svjetla: fluo T5 cijevi

Raster: LLP mikro zrcalni sa dvostrukom parabolikom, uzdužne i poprečne lamele sa 99,9% čistoće aluminija

Montaža: pomoću vijaka na strop, vješanje na čelične visilice

Spajanje: skidanjem rastera i bočnice dostupne su priključne stezaljke i ostale električne komponente

Prema zahtjevu: panik, regulacijska jedinica DALI, DIM (vidi upute za naručivanje str. 180)

Housing: extruded aluminium profile

Standard color: white, anodized aluminium, black finely textured

Power: 230V/50Hz

Supply unit: built in the housing

Light source: fluo T5 tubes

Louvre: LLP - micro mirror with double parabolic, lengthwise and transverse lamellas in 99,9% pure aluminium.

Mounting: with screws to the ceiling, hanging on suspended steel wires

Connecting: through removing the louvre and the side wall, connection clamps and all other electronic components are available

On request: emergency light, regulation unit DALI, DIM (see ordering instructions on pg. 180)

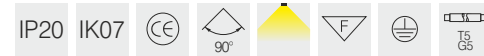

Prema zahtjevu:
On request:

Art.	W	K	V	AxBxH	kg
T5					
2291114	1x14W	3K/4K	230V	574x82x110	2,3
2291124	1x24W	3K/4K	230V	574x82x110	2,3
2291128	1x28W	3K/4K	230V	1174x82x110	3,7
2291135	1x35W	3K/4K	230V	1474x82x110	4,8
2291149	1x49W	3K/4K	230V	1474x82x110	4,8
2291154	1x54W	3K/4K	230V	1174x82x110	3,7
2291180	1x80W	3K/4K	230V	1474x82x110	4,8



Ukrasna rozeta s prozirnim dekorativnim kabelom L=1500mm
Decorative box with decorative transparent cable L=1500mm
art. 297



Sajla za vješanje
(2 kom potrebna) L=1500mm
Hanging wire
(2 pcs needed) L=1500mm
art. 285

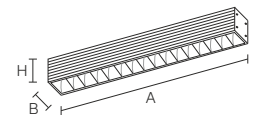

SIDE LLP art. 2291128

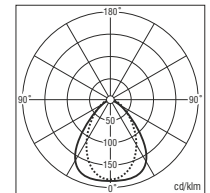

Side opal

Nadgradna/viseća svjetiljka / Surface mounted/suspended lamp

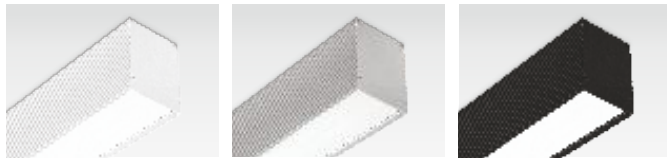
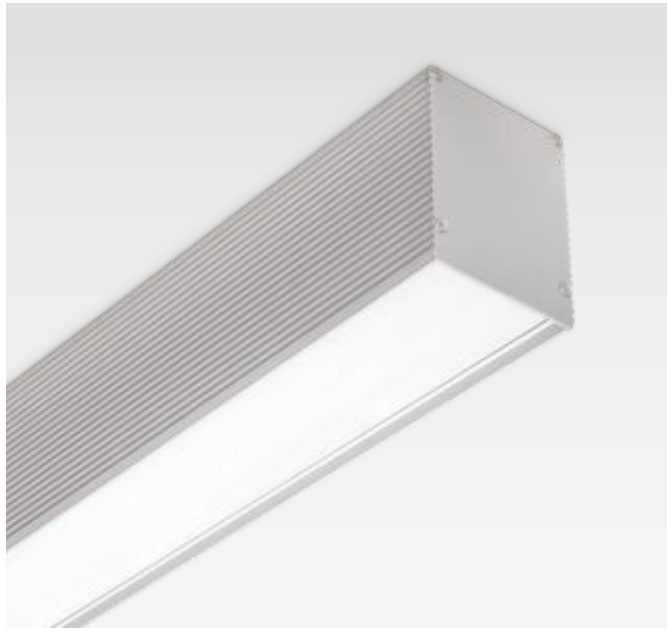

BIJELA/WHITE (W)

ANODIZED AL. (A)

CRNA/BLACK (B)

Art.	W	K	V	lm	AxBxH	kg
T5						
2301114	1x14W	3K/4K	230V		574x82x110	2,2
2301124	1x24W	3K/4K	230V		574x82x110	2,2
2301154	1x54W	3K/4K	230V		1174x82x110	3,6
2301128	1x28W	3K/4K	230V		1174x82x110	3,6
2301135	1x35W	3K/4K	230V		1474x82x110	4,7
2301149	1x49W	3K/4K	230V		1474x82x110	4,7
2301180	1x80W	3K/4K	230V		1474x82x110	4,7
LED						
2301711	12,4W	3K/4K	350mA	1680/1740	574x82x110	3,5
2301712	19,3W	3K/4K	300mA	2720/2810	574x82x110	3,5
2301721	24,8W	3K/4K	350mA	3360/3480	1174x82x110	4,5
2301722	38,6W	3K/4K	300mA	5280/5460	1174x82x110	4,4
2301731	31,0W	3K/4K	350mA	4200/4350	1474x82x110	5,3
2301732	48,2W	3K/4K	300mA	6800/7020	1474x82x110	5,4
2301741	37,2W	3K/4K	350mA	5040/5220	1700x82x110	6,2

Kućište: ekstrudirani aluminijski profil

Standardna boja: bijela, anodizirani aluminiij, crna finostrukturna

Napajanje: 230V/50Hz

Električne komponente: ugrađene u kućište

Izvor svjetla: fluo T5 cijevi, LED generacije 3, self-cooling, MacAdam 3 CRI>80; LED min 60.000h L80F50 na Tp=65°C; EEI A++

Difuzor: protubliješteći opalni difuzor homogenog efekta "crystal ice"

Montaža: pomoću vijaka na strop, vješanje na čelične visilice

Spajanje: demontažom difuzora i bočnice dostupne su priključne stezaljke

Prema zahtjevu: panik, regulacijska jedinica DALI, DIM (vidi upute za naručivanje str. 180)

Housing: extruded aluminium profile

Standard color: white, anodized aluminium, black finely textured

Power: 230V/50Hz

Supply unit: built in the housing

Light source: fluo T5 tubes, LED generation 3, self-cooling; MacAdam 3 CRI>80; LED min 60.000h L80F50 on Tp=65°C. EEI A++

Diffuser: anti-glare opal diffuser with homogenous effect "crystal ice"

Mounting: with screws to the ceiling, hanging on suspended steel wires

Connecting: through demounted diffuser and side wall, connection clamps are available

On request: emergency light, regulation unit DALI, DIM (see ordering instructions on pg. 180)



Prema zahtjevu: EM 1h, EM 3h, DALI, DIM



Ukrasna rozeta s prozirnim dekorativnim kabelom L=1500mm
Decorative box with decorative transparent cable L=1500mm
art. 297



Sajla za vješanje (2 kom potrebna) L=1500mm
Hanging wire (2 pcs needed) L=1500mm
art. 285

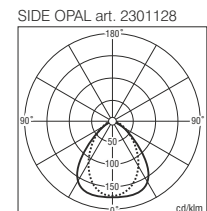
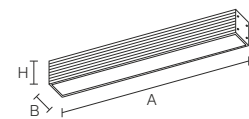





AF

AF profilna aluminijska asimetrična svjetiljka za zidnu i stropnu montažu sa fluorescentnim ili fluokompaktnim izvorima svjetlosti u stupnju zaštite IP55. Sa mogućnošću aplikacije prekidača, utičnica IP55 omogućuje nesmetanu ugradnju u vlažne prostore kao što su sanitarni prostori, kuhinje...

AF profile aluminum asymmetric fixture for wall and ceiling mounting with fluorescent or fluocompact light sources in protection degree IP55. With the possibility of applying switches and IP55 sockets, installation in wet areas is enabled, such as bathrooms, kitchens...

NAMJENA / USAGE



Nadgradna/zidna svjetiljka / Surface/wall mounted lamp



Kućište: ekstrudirani aluminijski profil

Standardna fino strukturna boja: bijela

Napajanje: 230V/50Hz

Električne komponente: ugrađene u kućište

Izvor svjetla: fluo T5 i T8 cijevi

Odasiyač: reflektor iz 99,9% metaliziranog aluminija

Difuzor: zaštitni polikarbonatni prizmatični difuzor protiv blještanja

Montaža: pomoću vijaka na strop/zid

Spajanje: skidanjem difuzora i odasiyača dostupne su priključne stezaljke i ostale električne komponente

Prema zahtjevu: panik, DALI, DIM (vidi upute za naručivanje str. 180)

Housing: extruded aluminium profile

Standard finely textured color: white

Power: 230V/50Hz

Supply unit: built in the housing

Light source: fluo T5 and T8 tubes

Reflector: reflector from 99,9% metallized aluminium

Diffuser: protective polycarbonate prismatic diffuser

Mounting: with screws to the ceiling/wall

Connecting: through removing the reflector and diffuser, connection clamps and all other electronic components are available

On request: emergency light, DALI, DIM (see ordering instructions on pg. 180)



Prema zahtjevu:
On request:



Art.	W	K	V	A x B x H	kg
T8					
2501115	1x15W	3K/4K	230V	500x117x65	2,0
2501118	1x18W	3K/4K	230V	650x117x65	2,2
2501130	1x30W	3K/4K	230V	955x117x65	2,8
2501136	1x36W	3K/4K	230V	1260x117x65	3,4
2501158	1x58W	3K/4K	230V	1560x117x65	4,6
T5					
2501114	1x14W	3K/4K	230V	610x117x65	1,8
2501121	1x21W	3K/4K	230V	910x117x65	2,3
2501124	1x24W	3K/4K	230V	610x117x65	1,8
2501128	1x28W	3K/4K	230V	1210x117x65	3,1
2501135	1x35W	3K/4K	230V	1510x117x65	3,7
2501139	1x39W	3K/4K	230V	1510x117x65	2,3
2501149	1x49W	3K/4K	230V	1510x117x65	3,7
2501154	1x54W	3K/4K	230V	1210x117x65	3,1
2501180	1x80W	3K/4K	230V	1510x117x65	3,7
2501214	2x14W	3K/4K	230V	610x117x65	1,9
2501221	2x21W	3K/4K	230V	910x117x65	2,4
2501224	2x24W	3K/4K	230V	610x117x65	1,9
2501228	2x28W	3K/4K	230V	1210x117x65	3,2



Prekidač na lijevoj strani, povećava duljinu svjetiljke za 10 cm
Switch on the left side, increases the total length by 10mm
art. 710



Utičnica s poklopcem IP55 na desnoj strani, povećava ukupnu dužinu svjetiljke 20mm
Socket with cap IP55 on the right side, increases the total lamp length for 20mm
art. 711



Transformator 20W
Transformer 20W
art. 712



Potezni prekidač na lijevoj strani L=310mm
Pull switch on the right side L=310mm
art. 715



Doplata za klasu II
Additional payment for class II
art. 716

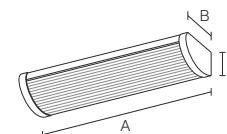

AF art. 2501118

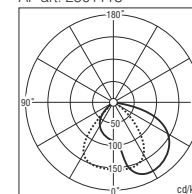

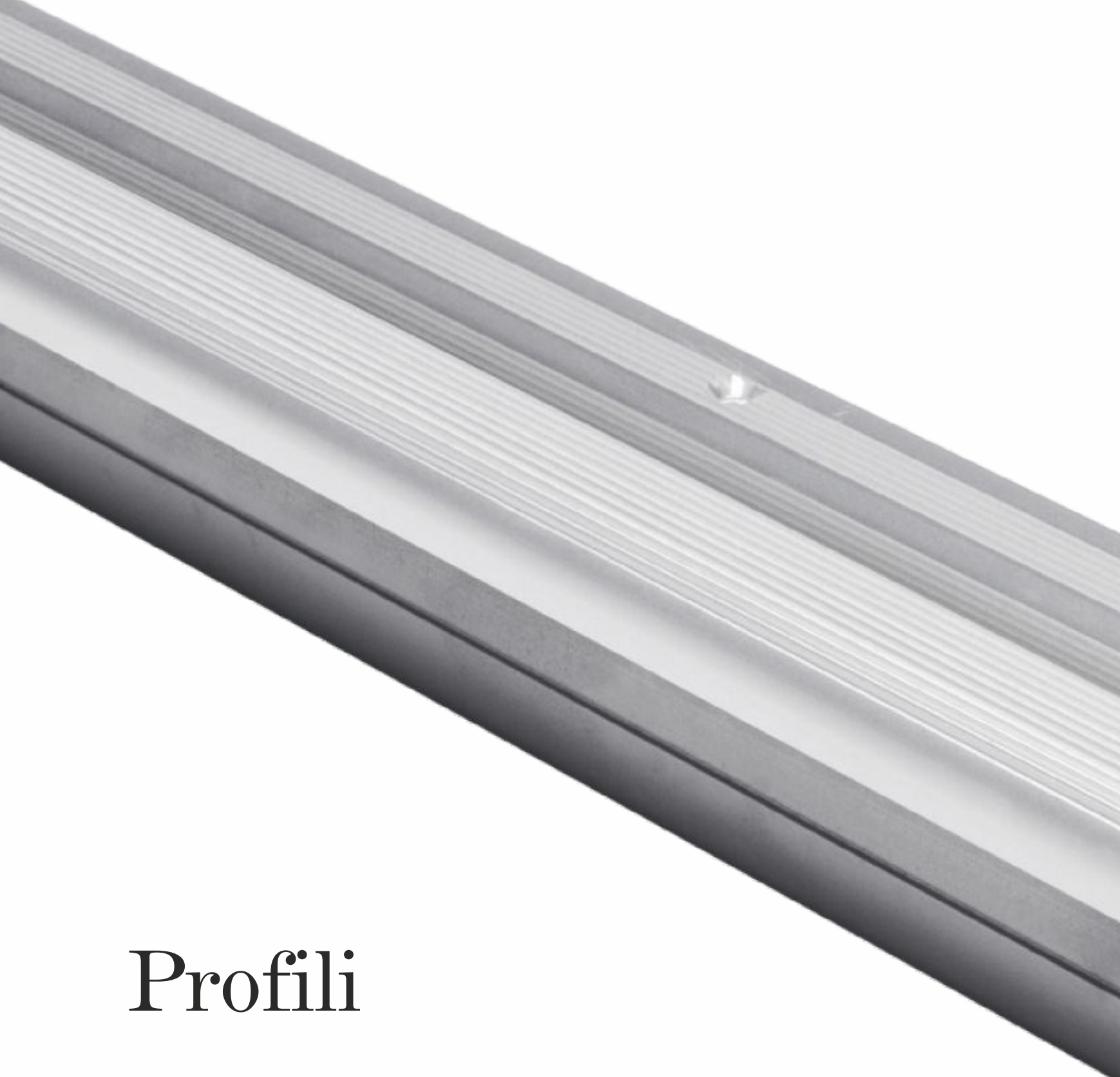

Profili

NAMJENA / USAGE



Storm

Nadgradna LED svjetiljka / Surface mounted LED lamp



Kućište: ekstrudirani aluminijski profil
Standardna boja: anodizirani aluminij
Električne komponente: odvojene napojne jedinice, naručuju se zasebno str. 176
Izvor svjetla: LED SMD tehnologije
Difuzor: od satiniranog protubljajećeg polikarbonata homogenog efekta
Montaža: pomoću "klik" nosača
Spajanje: na priključni kabel, kojeg je na osnovu zahtjeva moguće pozicionirati na početku ili kraju profila
Prema zahtjevu: regulacijska jedinica DALI, DIM, RGB DMX upravljanje (vidi upute za naručivanje str. 180)

Housing: extruded aluminium profile
Standard color: anodized aluminium
Supply unit: separated power supplies, ordered separately pg. 176
Light source: LED with SMD technology
Diffuser: from satinated, anti-glare polycarbonate with homogenous effect
Mounting: with "clip on" carrier
Connecting: on the connection cable which one can be positioned on to beginning or ending of the profile, based on request
On request: regulation unit DALI, DIM, RGB DMX (see ordering instructions on pg. 180)



Prema zahtjevu:
 On request: DALI, DIM, DMX

Art.	W	K	V	lm	A x B x H
LED					
2581701	4,8 W	3K/4K	24V	320/340	1000x18x8
2581702	7,2 W	3K/4K	24V	490/510	1000x18x8
2581703	14,4 W	3K/4K	24V	980/1020	1000x18x8
2581704	RGB	3K/4K	24V		1000x18x8



Nosač za montažu
 Mounting bracket
 h = 7mm
art. 423

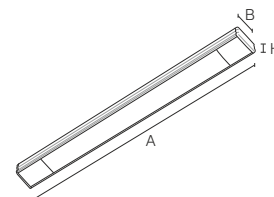

STORM art. 2581701

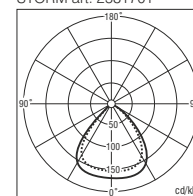

Angle

Nadgradna LED svjetiljka / Surface mounted LED lamp



Kućište: ekstrudirani aluminijski profil
Standardna boja: anodizirani aluminij
Električne komponente: odvojene napojne jedinice, naručuju se zasebno str. 176
Izvor svjetla: LED SMD tehnologije
Difuzor: od satiniranog protublještećeg polikarbonata homogenog efekta
Montaža: pomoću "klik" nosača
Spajanje: na priključni kabel, kojeg je na osnovu zahtjeva moguće pozicionirati na početku ili kraju profila
Prema zahtjevu: regulacijska jedinica DALI, DIM, RGB DMX upravljanje (vidi upute za naručivanje str. 180)

Housing: extruded aluminium profile
Standard color: anodized aluminum
Supply unit: separated power supplies, ordered separately pg. 176
Light source: LED with SMD technology
Diffuser: from satinated, anti-glare polycarbonate with homogenous effect
Mounting: with "clip on" carrier
Connecting: on the connection cable which one can be positioned on to beginning or ending of the profile, based on request
On request: regulation unit DALI, DIM, RGB DMX (see ordering instructions on pg. 180)



Prema zahtjevu:
 On request:



Art.	W	K	V	lm	A x B x H
LED					
2554705	4,8 W	3K/4K	24V	320/340	1000x19x19
2554707	7,2 W	3K/4K	24V	490/510	1000x19x19
2554715	14,4 W	3K/4K	24V	980/1020	1000x19x19
2554716	RGB	3K/4K	24V		1000x19x19



Nosač za montažu
 Mounting bracket
 h=3mm
art. 424

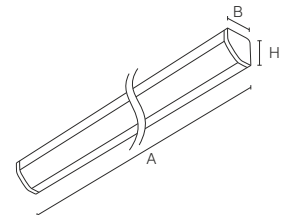

ANGLE art. 2554705

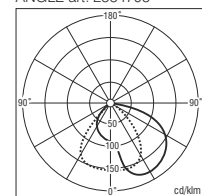

Procover 1

Ugradna/nadgradna LED svjetiljka / Recessed/surface mounted LED lamp



Kućište: ekstrudirani aluminijski profil
Standardna boja: anodizirani aluminij
Električne komponente: odvojene napojne jedinice, naručuju se zasebno str. 176
Izvor svjetla: LED SMD tehnologije
Difuzor: od satiniranog protublještećeg polikarbonata homogenog efekta
Montaža: pomoću "klik" nosača
Spajanje: na priključni kabel, kojeg je na osnovu zahtjeva moguće pozicionirati na početku ili kraju profila
Prema zahtjevu: regulacijska jedinica DALI, DIM, RGB DMX upravljanje (vidi upute za naručivanje str. 180)

Housing: extruded aluminium profile
Standard color: anodized aluminium
Supply unit: separated power supplies, ordered separately pg. 176
Light source: LED with SMD technology
Diffuser: from satinated, anti-glare polycarbonate with homogenous effect
Mounting: with "clip on" carrier
Connecting: on the connection cable which one can be positioned on to beginning or ending of the profile, based on request
On request: regulation unit DALI, DIM, RGB DMX (see ordering instructions on pg. 180)

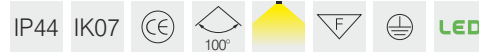

Prema zahtjevu:
 On request: DALI, DIM, DMX

Art.	W	K	V	lm	A x B x H
LED					
2592701	4,8 W	3K/4K	24V	320/340	1000x25x7
2592702	7,2 W	3K/4K	24V	490/510	1000x25x7
2592703	14,4 W	3K/4K	24V	980/1020	1000x25x7
2592704	RGB	3K/4K	24V		1000x25x7



Nosač za montažu
 Mounting bracket
 h=7mm
art. 423

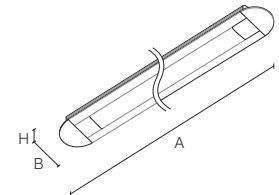

PROCOVER 1 art. 2592701

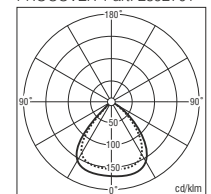

Procover 2

Ugradna/nadgradna LED svjetiljka / Recessed/surface mounted LED lamp



Kućište: ekstrudirani aluminijski profil
Standardna boja: anodizirani aluminij
Električne komponente: odvojene napojne jedinice, naručuju se zasebno str. 176
Izvor svjetla: LED SMD tehnologije
Difuzor: od satiniranog protublještećeg polikarbonata homogenog efekta
Montaža: pomoću "klik" nosača
Spajanje: na priključni kabel, kojeg je na osnovu zahtjeva moguće pozicionirati na početku ili kraju profila
Prema zahtjevu: regulacijska jedinica DALI, DIM, RGB DMX upravljanje (vidi upute za naručivanje str. 180)

Housing: extruded aluminium profile
Standard color: anodized aluminium
Supply unit: separated power supplies, ordered separately pg. 176
Light source: LED with SMD technology
Diffuser: from satinated, anti-glare polycarbonate with homogenous effect
Mounting: with "clip on" carrier
Connecting: on the connection cable which one can be positioned on to beginning or ending of the profile, based on request
On request: regulation unit DALI, DIM, RGB DMX (see ordering instructions on pg. 180)

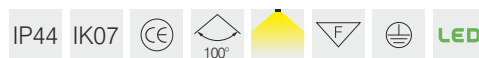

Prema zahtjevu:
 On request: DALI, DIM, DMX

Art.	W	K	V	lm	A x B x H
LED					
2592713	4,8 W	3K/4K	24V	320/340	1000x23x13
2592714	7,2 W	3K/4K	24V	490/510	1000x23x13
2592715	14,4 W	3K/4K	24V	980/1020	1000x23x13
2592716	RGB	3K/4K	24V		1000x23x13

 Nosač za montažu
 Mounting bracket
 h = 7mm
art. 423

IP65
 Zalijevanje - IP65 1m
 Sealing - IP65 1m
art. 535

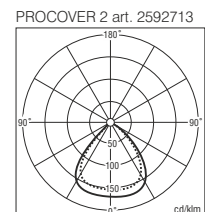
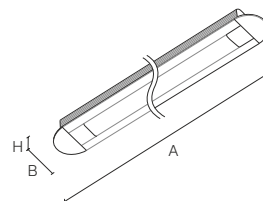

Profile led

Nadgradna LED svjetiljka / Surface mounted LED lamp



Kućište: ekstrudirani aluminijski profil

Standardna boja: anodizirani aluminij

Električne komponente: odvojene napojne jedinice, naručuju se zasebno str. 176

Izvor svjetla: LED SMD tehnologije

Montaža: pomoću "klik" nosača

Spajanje: na priključni kabel, kojeg je na osnovu zahtjeva moguće pozicionirati na početku ili kraju profila

Prema zahtjevu: regulacijska jedinica DALI, DIM, RGB DMX upravljanje (vidi upute za naručivanje str. 180)

Housing: extruded aluminium profile

Standard color: anodized aluminium

Supply unit: separated power supplies, ordered separately pg. 176

Light source: LED with SMD technology

Mounting: with "clip on" carrier

Connecting: on the connection cable which one can be positioned on to beginning or ending of the profile, based on request

On request: regulation unit DALI, DIM, RGB DMX (see ordering instructions on pg. 180)

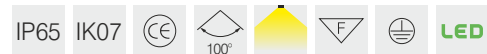

Prema zahtjevu:
On request:



Art.	W	K	V	lm	A x B x H
LED					
2471700	4,8 W	3K/4K	24V	320/340	1000x14x8
2471701	7,2 W	3K/4K	24V	490/510	1000x14x8
2471702	14,4 W	3K/4K	24V	980/1020	1000x14x8
2471703	RGB	3K/4K	24V		1000x14x8



Nosač za montažu
Mounting bracket
h=5mm
art. 419

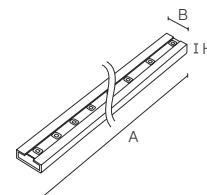

PROFILE art. 2471700

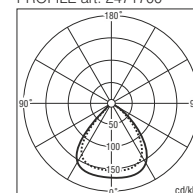

Profiline

Nadgradna LED svjetiljka / Surface mounted LED lamp



Kućište: ekstrudirani aluminijski profil
Standardna boja: anodizirani aluminij
Električne komponente: odvojene napojne jedinice, naručuju se zasebno str. 176
Izvor svjetla: LED SMD tehnologije
Difuzor: od satiniranog protubljestećeg polikarbonata homogenog efekta
Montaža: pomoću "klik" nosača
Spajanje: na priključni kabel, kojeg je na osnovu zahtjeva moguće pozicionirati na početku ili kraju profila
Prema zahtjevu: regulacijska jedinica DALI, DIM, RGB DMX upravljanje (vidi upute za naručivanje str. 180)

Housing: extruded aluminium profile
Standard color: anodized aluminium
Supply unit: separated power supplies, ordered separately pg. 176
Light source: LED with SMD technology
Diffuser: from satinated, anti-glare polycarbonate with homogenous effect
Mounting: with "clip on" carrier
Connecting: on the connection cable which one can be positioned on to beginning or ending of the profile, based on request
On request: regulation unit DALI, DIM, RGB DMX (see ordering instructions on pg. 180 on pg. 180)



Prema zahtjevu:
 On request:



Art.	W	K	V	lm	A x B x H
LED					
2451700	4,8 W	3K/4K	24V	320/340	1000x20x20
2451701	7,2 W	3K/4K	24V	490/510	1000x20x20
2451702	14,4 W	3K/4K	24V	980/1020	1000x20x20
2451712	RGB	3K/4K	24V		1000x20x20



Nosač za montažu
 Mounting bracket
 h = 11mm
art. 418

IP65

Zalijevanje - IP65 1m
 Sealing - IP65 1m
art. 535

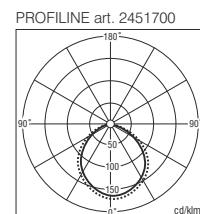
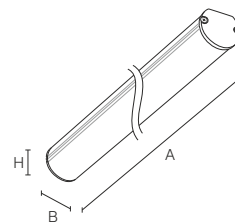

Haven

Ugradna LED svjetiljka / Recessed LED lamp



Kućište: ekstrudirani aluminijski profil

Standardna boja: anodizirani aluminij

Električne komponente: odvojene napojne jedinice, naručuju se zasebno str. 176

Izvor svjetla: LED SMD tehnologije

Difuzor: od satiniranog protublještećeg polikarbonata homogenog efekta

Montaža: ugradnja u otvor pomoću opruga

Spajanje: na priključni kabel, kojeg je na osnovu zahtjeva moguće pozicionirati na početku ili kraju profila

Prema zahtjevu: regulacijska jedinica DALI, DIM, RGB DMX upravljanje (vidi upute za naručivanje str. 180)

Housing: extruded aluminium profile

Standard color: anodized aluminium

Supply unit: separated power supplies, ordered separately pg. 176

Light source: LED with SMD technology

Diffuser: from satinated, anti-glare polycarbonate with homogenous effect

Mounting: with springs into opening

Connecting: on the connection cable which one can be positioned on to beginning or ending of the profile, based on request

On request: regulation unit DALI, DIM, RGB DMX (see ordering instructions on pg. 180)



Prema zahtjevu:
On request:



Art.	W	K	V	lm	A x B x H	
LED						
2612701	4,8 W	3K/4K	24V	320/340	1000x28x70	997x67
2612702	7,2 W	3K/4K	24V	490/510	1000x28x70	997x67
2612703	14,4 W	3K/4K	24V	980/1020	1000x28x70	997x67
2612704	RGB	3K/4K	24V		1000x28x70	997x67

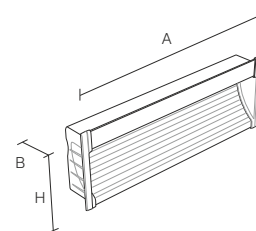

HAVEN art. 2612701

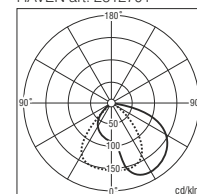

Stepline

Nadgradna LED svjetiljka / Surface mounted LED lamp

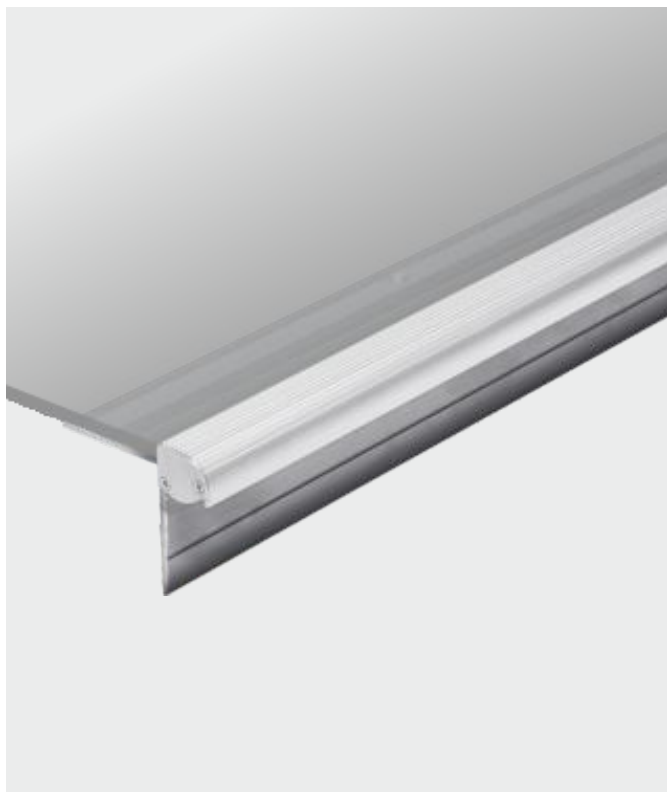

Kućište: ekstrudirani aluminijski profil
Standardna boja: anodizirani aluminij
Električne komponente: odvojene napojne jedinice, naručuju se zasebno str. 176
Izvor svjetla: LED SMD tehnologije
Difuzor: od satiniranog protublještećeg polikarbonata homogenog efekta
Montaža: na rub stepenice prije stavljanja keramike
Spajanje: na priključni kabel, kojeg je na osnovu zahtjeva moguće pozicionirati na početku ili kraju profila
Prema zahtjevu: regulacijska jedinica DALI, DIM, RGB DMX upravljanje (vidi upute za naručivanje str. 180)

Housing: extruded aluminium profile
Standard color: anodized aluminium
Supply unit: separated power supplies, ordered separately pg. 176
Light source: LED with SMD technology
Diffuser: from satinated, anti-glare polycarbonate with homogenous effect
Mounting: on the edge of steps before applying the ceramics
Connecting: on the connection cable which one can be positioned on to beginning or ending of the profile, based on request
On request: regulation unit DALI, DIM, RGB DMX (see ordering instructions on pg. 180)



Prema zahtjevu:
 On request: DALI, DIM, DMX

Art.	W	K	V	lm	A x B x H
LED					
2431712	4,8 W	3K/4K	24V	320/340	1000x65x57

Završna bočnica (par)
 Ending plate (pair)
art. 304

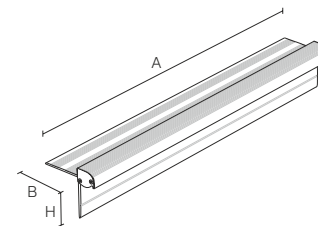

Protuklizna površina
 Anti-slip surface



Stepline carpet

Nadgradna LED svjetiljka / Surface mounted LED lamp



Kućište: ekstrudirani aluminijski profil
Standardna boja: anodizirani aluminij
Električne komponente: odvojene napojne jedinice, naručuju se zasebno str. 176
Izvor svjetla: LED SMD tehnologije
Difuzor: od satiniranog protublještećeg polikarbonata homogenog efekta
Montaža: vijcima na rub stepenica
Spajanje: na priključni kabel, kojeg je na osnovu zahtjeva moguće pozicionirati na početku ili kraju profila
Prema zahtjevu: regulacijska jedinica DALI, DIM, RGB DMX upravljanje (vidi upute za naručivanje str. 180)

Housing: extruded aluminium profile
Standard color: anodized aluminium
Supply unit: separated power supplies, ordered separately pg. 176
Light source: LED with SMD technology
Diffuser: from satinated, anti-glare polycarbonate with homogenous effect
Mounting: with screws on edge of steps
Connecting: on the connection cable which one can be positioned on to beginning or ending of the profile, based on request
On request: regulation unit DALI, DIM, RGB DMX (see ordering instructions on pg. 180)

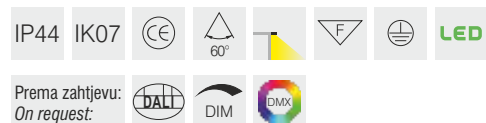

Art.	W	K	V	lm	A x B x H
LED					
2441705	4,8 W	3K/4K	24V	320/340	1000x65x57

Završna bočnica (par)
 Ending plate (pair)
art. 305

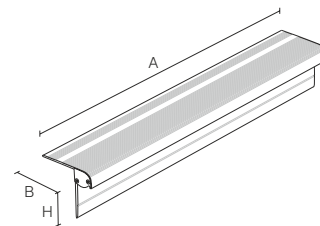

Protuklizna površina
 Anti-slip surface

Led traka

Fleksibilna LED traka / Flexible LED strip



Električne komponente: odvojene napojne jedinice (naručuju se zasebno str. 176)

Izvor svjetla: LED SMD tehnologije

Montaža: pričvršćivanjem na površinu ljepljenjem

Spajanje: na priključni kabel, kojeg je na osnovu zahtjeva moguće pozicionirati na početku ili kraju trake

Prema zahtjevu: regulacijska jedinica DALI, DIM, RGB DMX upravljanje (vidi upute za naručivanje str. 180)

Supply unit: separated power supplies (ordered separately pg. 176)

Light source: LED with SMD technology

Mounting: securing it to the surface

Connecting: on the connection cable which one can be positioned on to beginning or ending of the strip, based on request

On request: regulation unit DALI, DIM, RGB DMX (see ordering instructions on pg. 180)



Prema zahtjevu:
On request:



Art.	W	K	V	lm	A x B x H
LED IP33					
2631731	4,8 W	3K/4K	24V	320/340	1000x10x4
2631732	7,2 W	3K/4K	24V	490/510	1000x10x4
2631733	14,4 W	3K/4K	24V	980/1020	1000x10x4
LED IP55					
2641731	4,8 W	3K/4K	24V	320/340	1000x10x4
2641732	7,2 W	3K/4K	24V	490/510	1000x10x4
2641733	14,4 W	3K/4K	24V	980/1020	1000x10x4
2641702	RGB	3K/4K	24V		1000x10x4

IP55

Zalijeвање - IP55 1m
Sealing - IP55 1m
art. 535



Lite led

Ugradne spotlight svjetiljke izuzetne čvrstoće sa kućištem iz ljevanog aluminija obojenog termoeпокsidnom bojom idealne su za vanjsku upotrebu te sve vremenske uvjete.

LED izvor svjetlosti zaštićen je transparentnim polikarbonatom velike čvrstoće i izdržljivosti a montaža svjetiljke je moguća u gips ili u betonski zid pomoću kutije za montažu

Recessed spotlight luminaires of great durability with housing made from die cast aluminium body, covered with thermal epoxy color. Lite Led is ideal for exterior usage and all weather conditions. LED light source is protected with transparent polycarbonate of high durability and the mounting of the luminaire is possible in plaster or even in concrete walls thanks to a special box for concrete mounting.

NAMJENA / USAGE



Lite led maxi

Ugradna LED svjetiljka / Recessed LED lamp



Kućište: lijevani aluminij obojen termoeпокsidnom bojom namijenjenom za vanjske uvjete

Standardna finostrukturna boja: bijela, siva, crna

Napajanje: 230V/50Hz

Električne komponente: ugrađene u kućište

Izvor svjetla: LED

Difuzor: zaštitni transparentni polikarbonat

Montaža: u gipsani zid ili u kutiju za montažu u betonskom zidu

Spajanje: na priključni kabel

Housing: die-cast aluminium covered with thermal epoxy colour approved for external weather conditions

Standard finely structured color: white, gray, black

Power: 230V/50Hz

Supply unit: built in the housing

Diffuser: from protective transparent polycarbonate

Light source: LED

Mounting: into plaster wall or into mountage box for concrete walls

Connecting: to connecting cable



Art.	W	K	V	lm	A x B x H
LED					
7246703	3,0W	3K/4K	230V	305/320	250x250x120
7246706	6,0W	3K/4K	230V	610/640	250x140x120



Ugradna kutija za ugradnju u beton
Integrated box for installation into concrete
240x240x95mm



Ugradna kutija za ugradnju u beton
Integrated box for installation into concrete
240x130x95mm

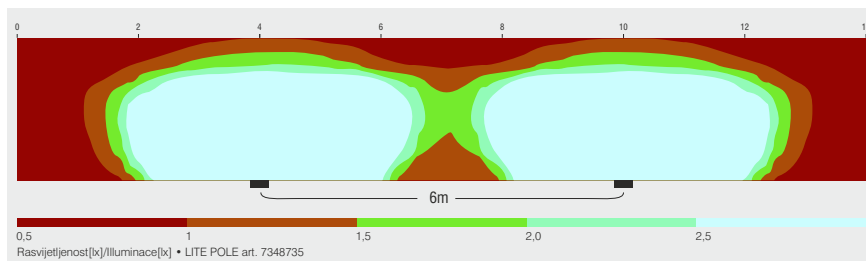
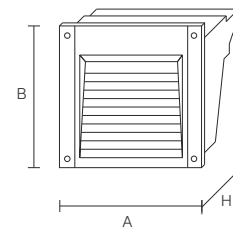

LITE art. 7246706

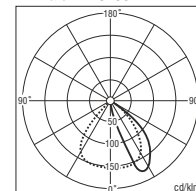

Led Line F

Ugradna podna lampa izrazite čvrstoće i otporna na sve vremenske uvjete.

Satinirano kaljeno staklo debljine 19mm tonirano je u zelenim tonovima te daje oku ugodan odsjaj a istovremeno je otporno na ogrebotine, udarce i velike pritiske, te se savršeno uklapa u sve vanjske prostore kojima je potrebna svjetlosna komponenta.

Recessed floor luminaire of exceptional hardness and resistant to all weather conditions.

Sattinated tempered glass with 19mm thickness is tinted green and emmits eye pleasing illumination, resistant to scratches, blows and great pressures and at the same time it complements perfectly all exterior spaces in need for illumination component.

NAMJENA / USAGE



Led line F

Ugradna podna svjetiljka / Recessed floor lamp



Kućište: od inoxa 316L

Napajanje: 24V

Električne komponente: odvojene napojne jedinice (napojne jedinice u kompletu)

Izvor svjetla: LED SMD tehnologije

Difuzor: satinirano kaljeno staklo debljine 19mm

Montaža: ugradnja u kutiju za montažu

Spajanje: izvan svjetiljke na konektore u IP zaštiti

Prema zahtjevu: regulacijska jedinica DIM
(vidi upute za naručivanje str. 180)

Housing: inox 316L

Power: 24V

Supply unit: separate supply units (supply units included)

Light source: LED with SMD technology

Diffuser: satinated tempered glass with 19mm thickness

Mounting: inserting in mounting box

Connecting: outside the lamp on IP protected connectors

On request: regulation unit DIM (see ordering instructions pg. 180)



Prema zahtjevu: 
On request: DIM

Art.	W	K	V	lm	AxBxH
LED					
2747712	6,0W	3K/4K	24V	370/390	1200x100x100
2747772	8,0W	3K/4K	24V	560/590	1200x100x100
2747752	17,0W	3K/4K	24V	1130/1170	1200x100x100

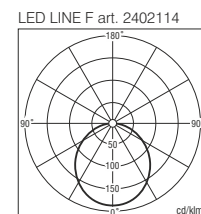
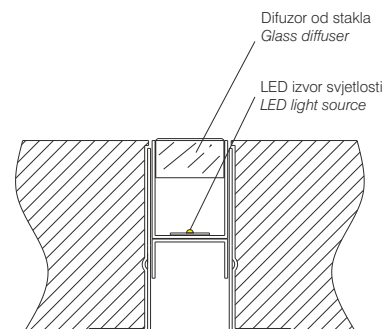
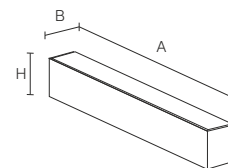

Mirage

Vanjski dekorativni stupovi izuzetne čvrstoće sa kućištem od INOX-a 316L obojenog termoeпокsidnom bojom idealne su za vanjsku upotrebu te sve vremenske uvjete.

LED izvor svjetlosti zaštićen je transparentnim polikarbonatom velike čvrstoće i izdržljivosti. Montaža se vrši pomoću anker vijaka i temeljne ploče.

Outdoor decorative bollards of great durability with housing made from INOX 316L, covered with thermal epoxy color.

Lite Led is ideal for exterior usage and all weather conditions.

LED light source is protected with transparent polycarbonate of high durability. Mounting is done with using anchor screws and fundamental galvanized metal sheet



NAMJENA / USAGE



Mirage

Ugradna LED svjetiljka / Recessed LED lamp



SIVA/GRAY (G)



CRNA/BLACK(B)

Kućište: od nehrđajućeg inox 316L

Standardna finostrukturna boja: siva, crna

Napajanje: 230V/50Hz

Električne komponente: ugrađene u kućište

Izvor svjetla: LED

Difuzor: zaštitni transparentni polikarbonat

Montaža: pomoću anker vijaka i temeljne toplocinčane metalne ploče

Spajanje: na priključni kabel

Housing: from rust resistant inox 316L

Standard finely structured color: gray, black

Power: 230V/50Hz

Supply unit: built in the housing

Diffuser: from protective transparent polycarbonate

Light source: LED

Mounting: using anchor screws and fundamental galvanized metal sheet

Connecting: to connecting cable



Art.	W	K	V	lm	A x B x H
LED					
7348715	3,0W	3K/4K	230V	305/320	185x105x350
7348725	6,0W	3K/4K	230V	610/640	185x105x500
7348735	6,0W	3K/4K	230V	610/640	185x105x800

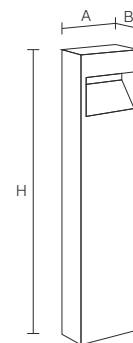
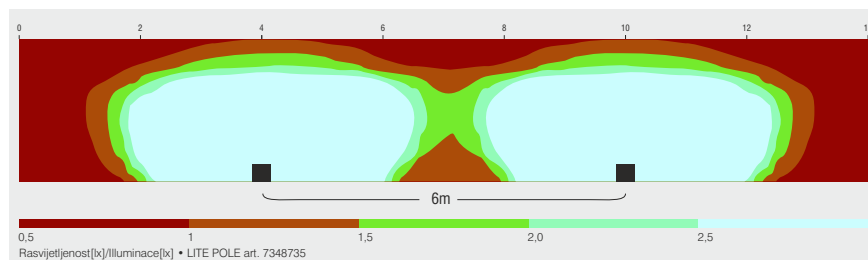

LITE STUP art. 7348735

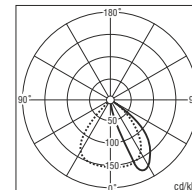

STATE

URBAN LIGHTING

Rasvjetni stup visoke kvalitete izrađen od ekstrudiranog aluminijskog profila velike čvrstoće. Osmišljen kao idealno rješenje za rasvjetu prometnica svih vrsta, šetnica, parkova i ostalih prostora gdje je potrebna vanjska rasvjeta te se svojim minimalističkim dizajnom uklapa u svako okruženje. Stup je dizajniran da radi u svim vremenskim uvjetima te je izuzetno otporan na temperaturne varijacije od -40°C do $+55^{\circ}\text{C}$.

High quality light pole made of high strength extruded aluminum profile. It is designed as an ideal solution for the illumination of all types of roads, walkways, parks and other areas needing outdoor lighting and with its minimalist design fits into any environment. Column is designed to work in all weather conditions and is highly resistant to temperature variations from -40°C to $+55^{\circ}\text{C}$.

NAMJENA / USAGE

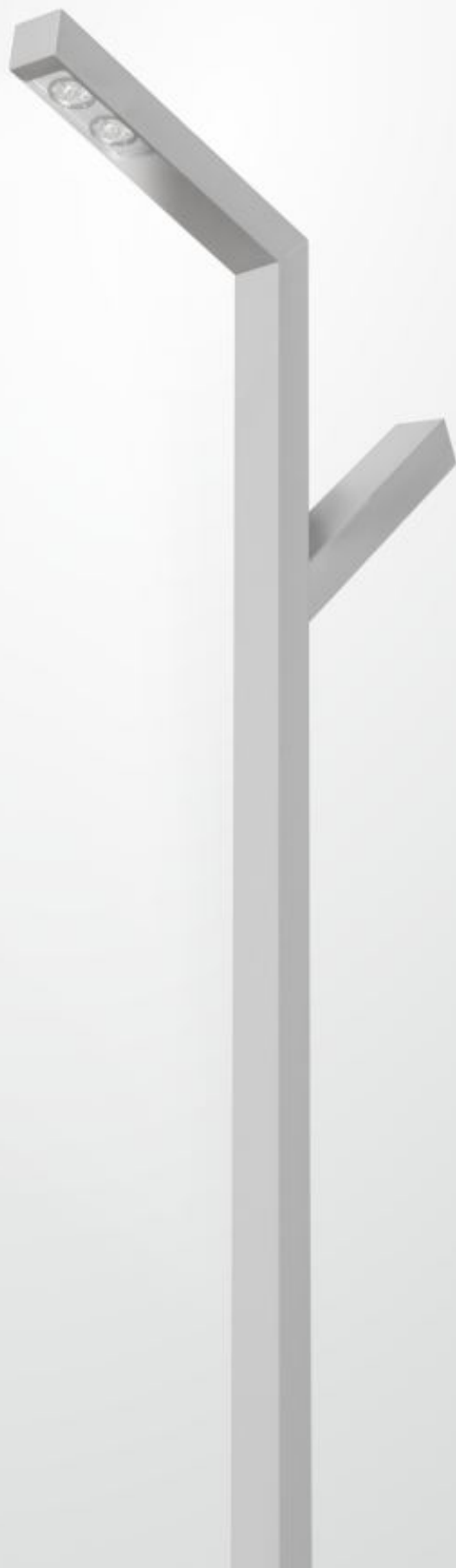
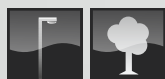

State wall

Zidni aluminijski rasvjetni LED stup / Wall mounted aluminium LED light pole



Kućište: ekstrudirani aluminijski profil 100x100mm

Standardna boja: siva RAL 9006

Napajanje: 230V/50Hz

Električne komponente: ugrađene u kućište

Izvor svjetla: LED najnovije generacije s asimetričnom širokosopnom optikom koji omogućuju visoku efikasnost i učinkovitost (simetrična po zahtjevu art. 426). Životni vijek LED izvora min 60.000h L80F50 na Tp 65°C EEI A++

Montaža: pomoću vijaka na zid s dodatnim nosačem

Spajanje: demontažom poklopca dostupne priključne stezaljke

Housing: extruded aluminum profile 100x100mm

Standard color: gray RAL 9006

Power: 230V/50Hz

Supply unit: built in the housing

Light source: LED latest generation with asymmetric flood optics that allow high efficiency and effectivity (symmetric on request art. 426). Lifetime of LED's 60.000h L80F50 on Tp 65°C

Mounting: with screws to the wall with additional carrier

Connecting: through removing protective cover, connection clamps are available

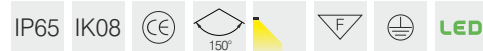

Art.	W	K	lm	A
LED				
7254730	20,0W	3K/4K	2902/2998	700
7254731	35,0W	3K/4K	4668/4824	700
7254732	50,2W	3K/4K	6318/6526	700

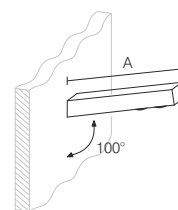
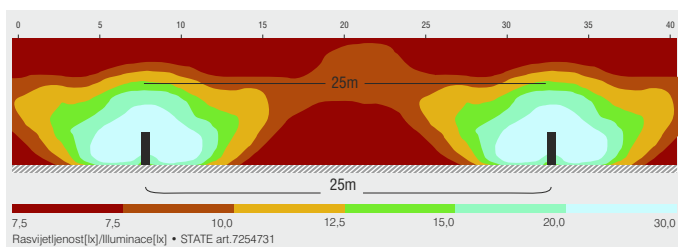
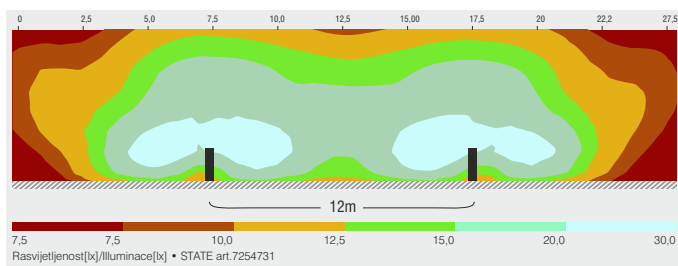

STATE art. 7254730

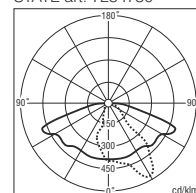

State mini

Aluminijski rasvjetni LED stup / Aluminium LED light pole



Kućište: ekstrudirani aluminijski profil 100x100mm, nosiva konstrukcija ojačana željeznom strukturom

Standardna boja: siva RAL 9006

Napajanje: 230V/50Hz

Električne komponente: ugrađene u kućište

Izvor svjetla: LED najnovije generacije s asimetričnom širokosnopnom optikom koji omogućuju visoku efikasnost i učinkovitost (simetrična po zahtjevu art. 426). Životni vijek LED izvora min 60.000h L80F50 na Tp 65°C EEI A++

Montaža: pomoću anker vijaka i temeljne toplocinčane metalne ploče

Spajanje: demontažom poklopca dostupne priključne stezaljke

Housing: extruded aluminum profile 100x100mm, columns are reinforced with steel structure

Standard color: gray RAL 9006

Power: 230V/50Hz

Supply unit: built in the housing

Light source: LED latest generation with asymmetric flood optics that allow high efficiency and effectivity (symmetric on request art. 426). Lifetime of LED's 60.000h L80F50 on Tp 65°C

Mounting: using anchor screws and fundamental galvanized metal sheet

Connecting: through removing protective cover, connection clamps are available

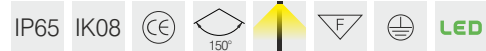

Art.	W	K	lm	A x H
7278730	10,0W	3K/4K	1451/1499	400x1000

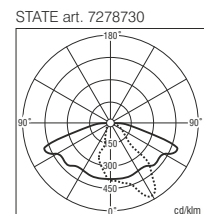
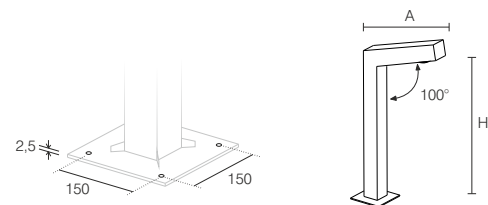



The image shows the exterior of a building with a textured, light-colored facade. A modern, rectangular light fixture is mounted on the wall, emitting a warm glow. Below the light, the name of the building is embossed in large, dark letters. The sky is a clear, deep blue.

ŠKOLSKO-GRADSKA
SPORTSKA DVORANA
PAZIN

State single

Aluminijski rasvjetni LED stup / Aluminium LED light pole

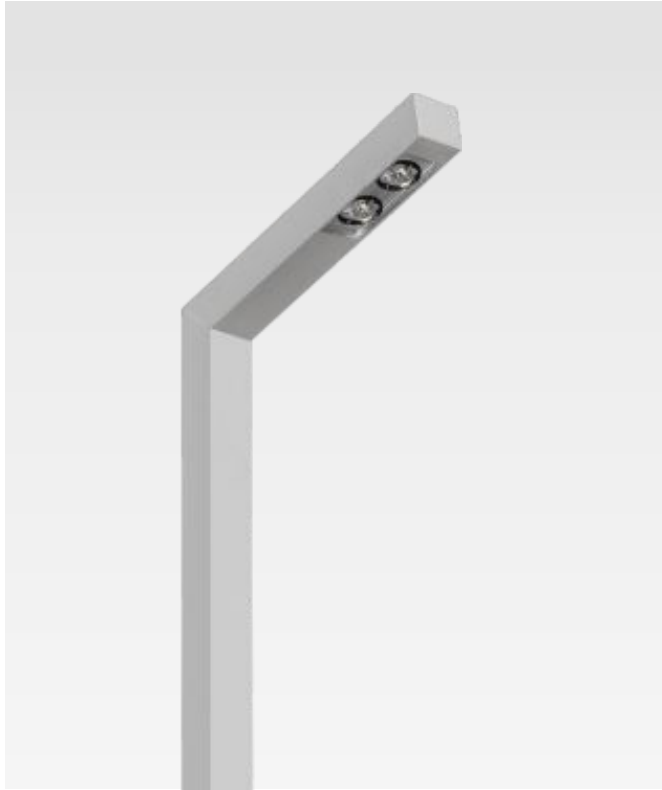

Kućiče: ekstrudirani aluminijski profil 100x100mm, nosiva konstrukcija ojačana željeznom strukturom

Standardna boja: siva RAL 9006

Napajanje: 230V/50Hz

Električne komponente: ugrađene u kućište

Izvor svjetla: LED najnovije generacije s asimetričnom širokosopnom optikom koji omogućuju visoku efikasnost i učinkovitost (simetrična po zahtjevu art. 426). Životni vijek LED izvora min 60.000h L80F50 na Tp 65°C EEI A++

Montaža: pomoću anker vijaka i temeljne toplocinčane metalne ploče

Spajanje: demontažom poklopca dostupne priključne stezaljke

Housing: extruded aluminum profile 100x100mm, columns are reinforced with steel structure

Standard color: gray RAL 9006

Power: 230V/50Hz

Supply unit: built in the housing

Light source: LED latest generation with asymmetric flood optics that allow high efficiency and effectivity (symmetric on request art. 426). Lifetime of LED's 60.000h L80F50 on Tp 65°C

Mounting: using anchor screws and fundamental galvanized metal sheet

Connecting: through removing protective cover, connection clamps are available

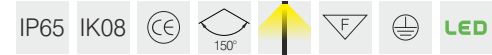

Art.	W	K	lm	A x H
LED				
7258730	20,0W	3K/4K	2902/2998	800x3000
7258731	35,0W	3K/4K	4668/4824	800x4000
7258732	50,2W	3K/4K	6318/6526	800x5000

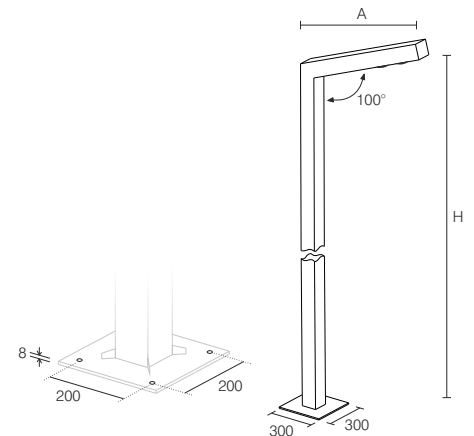
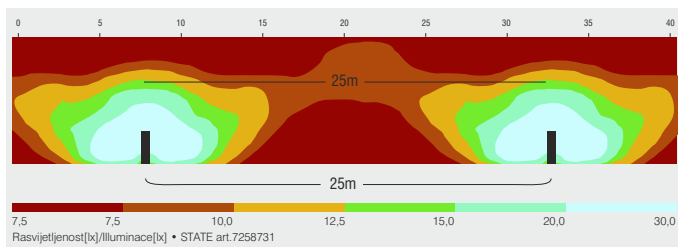
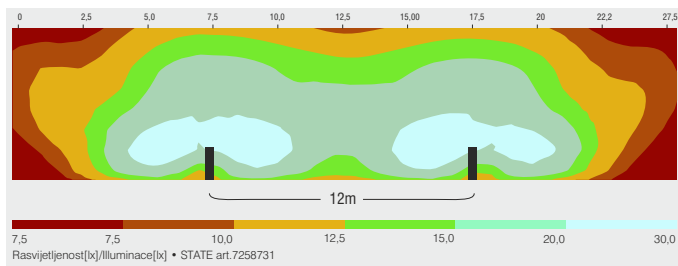

STATE art. 7258730

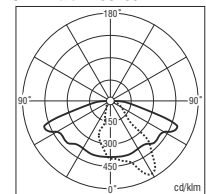

State double

Aluminijski rasvjetni LED stup / Aluminium LED light pole

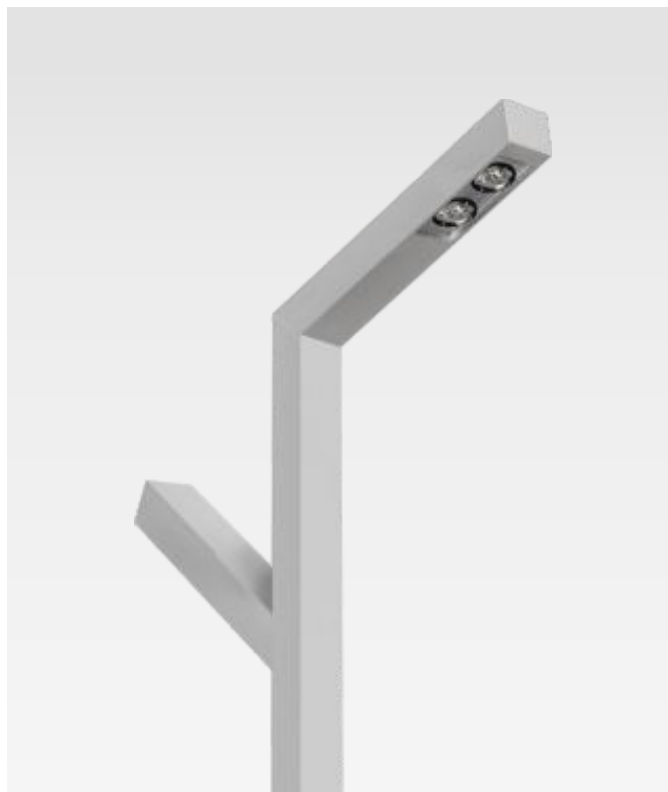

Kućište: ekstrudirani aluminijski profil 100x100mm, nosiva konstrukcija ojačana željeznom strukturom
Standardna boja: siva RAL 9006
Napajanje: 230V/50Hz
Električne komponente: ugrađene u kućište
Izvor svjetla: LED najnovije generacije s asimetričnom širokosnopnom optikom koji omogućuju visoku efikasnost i učinkovitost (simetrična po zahtjevu art. 426). Životni vijek LED izvora min 60.000h L80F50 na Tp 65°C EEI A++
Montaža: pomoću anker vijaka i temeljne toplocinčane metalne ploče
Spajanje: demontažom poklopca dostupne priključne stezaljke

Housing: extruded aluminum profile 100x100mm, columns are reinforced with steel structure

Standard color: gray RAL 9006

Power: 230V/50Hz

Supply unit: built in the housing

Light source: LED latest generation with asymmetric flood optics that allow high efficiency and effectivity (symmetric on request art. 426). Lifetime of LED's 60.000h L80F50 on Tp 65°C

Mounting: using anchor screws and fundamental galvanized metal sheet

Connecting: through removing protective cover, connection clamps are available

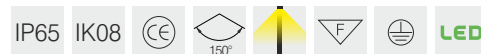

Art.	LED 1 W	LED 2 W	K	lm	A x H / H1
7268730	20,0W	35,0W	3K/4K	2902+4668/2998+4824	800x4000/3500
7268731	20,0W	50,2W	3K/4K	2902+6318/2998+6526	800x5000/3500

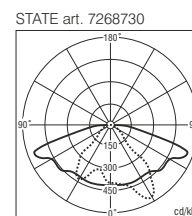
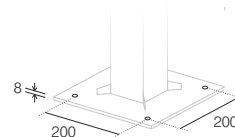
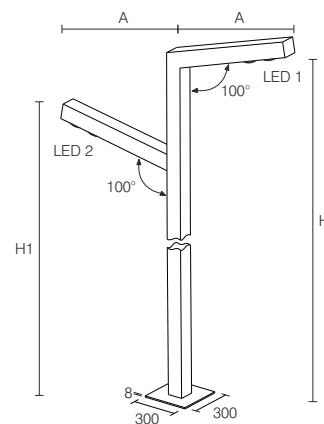
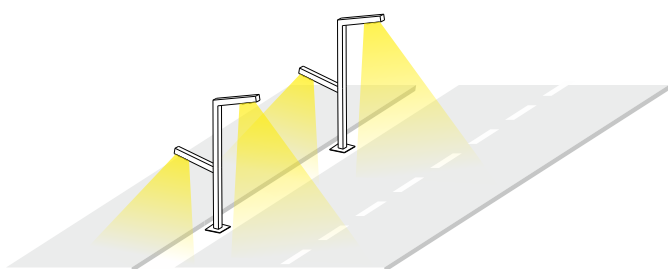
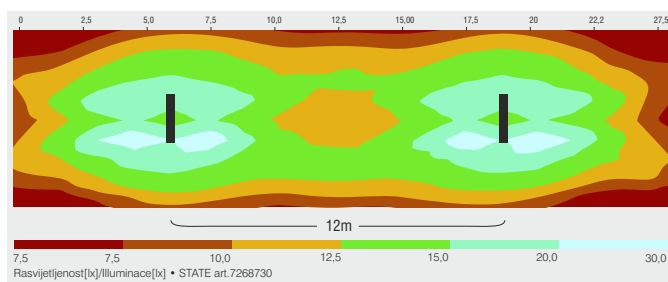

State double T

Aluminijski rasvjetni LED stup / Aluminium LED light pole



Kućište: ekstrudirani aluminijski profil 100x100mm, nosiva konstrukcija ojačana željeznom strukturom

Standardna boja: siva RAL 9006

Napajanje: 230V/50Hz

Električne komponente: ugrađene u kućište

Izvor svjetla: LED najnovije generacije s asimetričnom širokosopnom optikom koji omogućuju visoku efikasnost i učinkovitost (simetrična po zahtjevu art. 426). Životni vijek LED izvora min 60.000h L80F50 na T_p 65°C EEI A++

Montaža: pomoću anker vijaka i temeljne toplocinčane metalne ploče

Spajanje: demontažom poklopca dostupne priključne stezaljke

Housing: extruded aluminum profile 100x100mm, columns are reinforced with steel structure

Standard color: gray RAL 9006

Power: 230V/50Hz

Supply unit: built in the housing

Light source: LED latest generation with asymmetric flood optics that allow high efficiency and effectivity (symmetric on request art. 426). Lifetime of LED's 60.000h L80F50 on T_p 65°C

Mounting: using anchor screws and fundamental galvanized metal sheet

Connecting: through removing protective cover, connection clamps are available

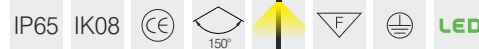

Art.	W	K	lm	A x H / H1
LED				
7268751	2x35,0W	3K/4K	9336/9648	800x4000
7268755	2x50,2W	3K/4K	12636/13052	800x5000

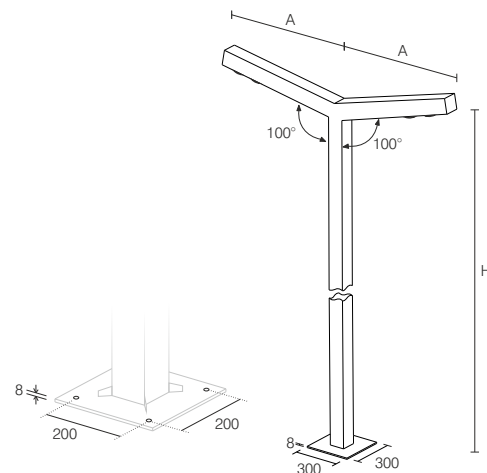
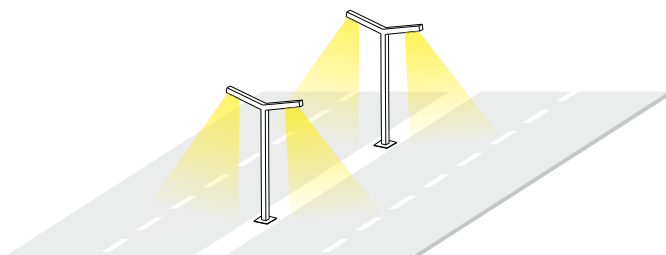
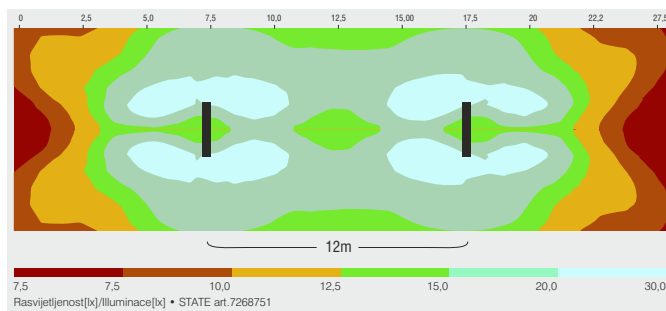

STATE art. 7268730

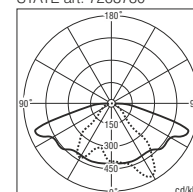

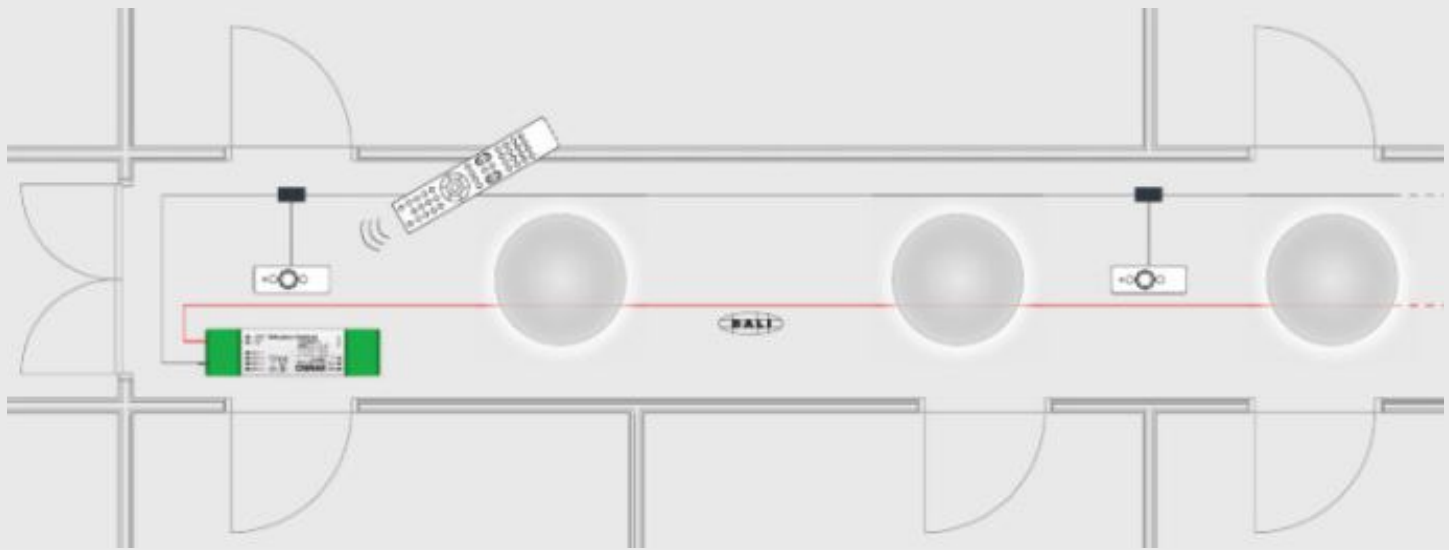

Sistem upravljanja svjetlom *Light management sistem*

Profesionalno rješenje za zahtjevnije projekte i zahtjeve najvišeg nivoa profesionalnosti, gdje se iziskuje maksimalni nivo komfora korisnika. Mogućnost programiranja 16 neovisnih fleksibilnih rasvjetnih grupa, 15 neovisnih rasvjetnih scena, mogućnost prilagođavanja nivoa komfora prema zahtjevu korisnika. Bežična tehnologija znatno olakšava montažu i korištenje kompletnog DALI sistema

Lighting management system for demanding lighting solutions where user comfort is highly considerable: 16 flexible lighting groups, 15 individually adjustable lighting scenes, various user interface options, radio technology simplifies installation of the user interfaces.

Dali

centralni digitalni sistem DALI / central digital system DALI

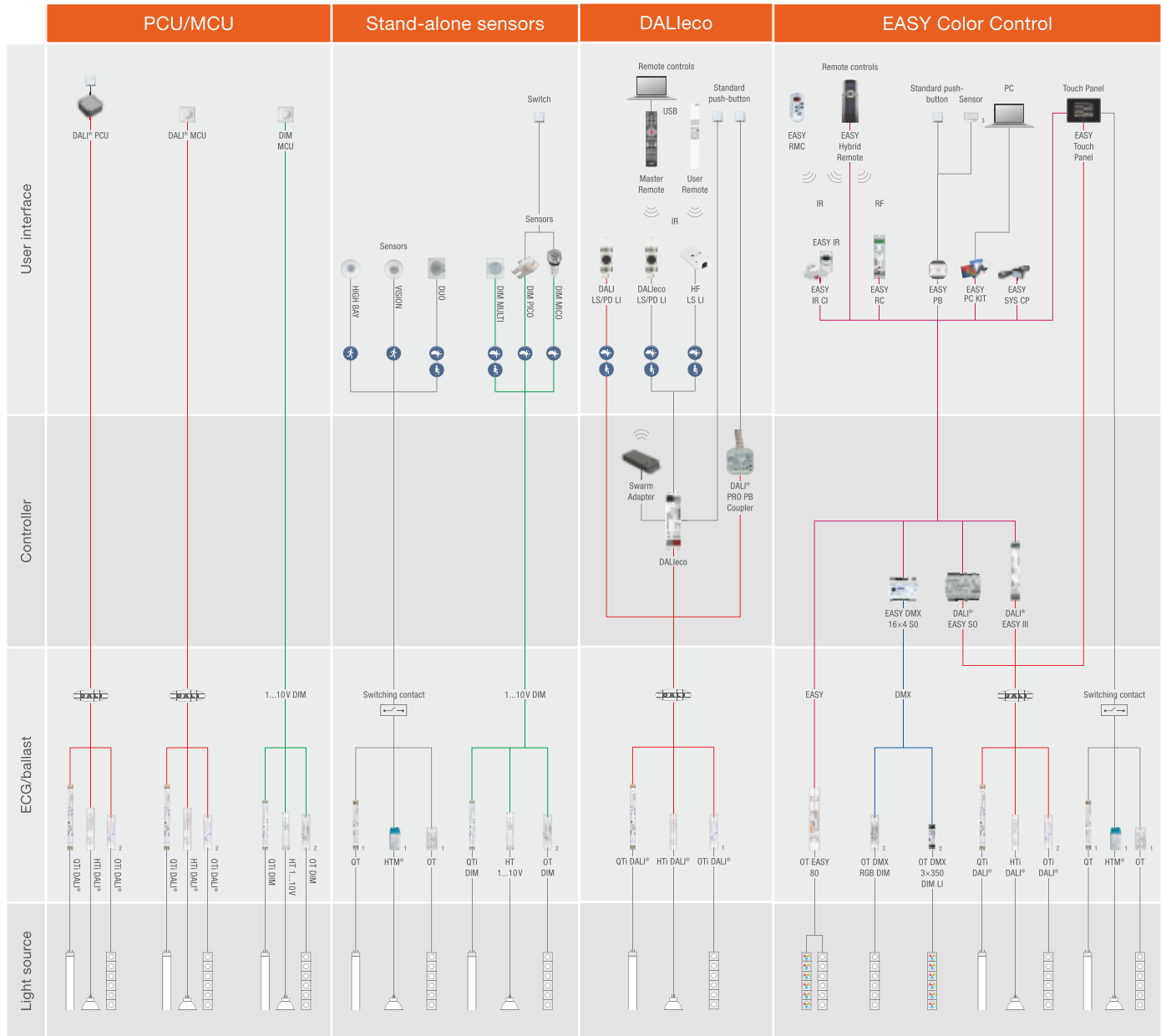

- Presence detection
- Motion detection
- Daylight detection
- DALI®
- 1...10V DIM
- DMX
- Powerline
- EASY
- ENCELUM™ network
- Customer network

¹ Non-dimmable QT, HT and OT control gears
² Suitable power supply required
³ Battery-less radio standard
⁴ Sensor with floating contact (e.g. DUO, VISION, HIGH BAY)

Dali

centralni digitalni sistem DALI / central digital system DALI

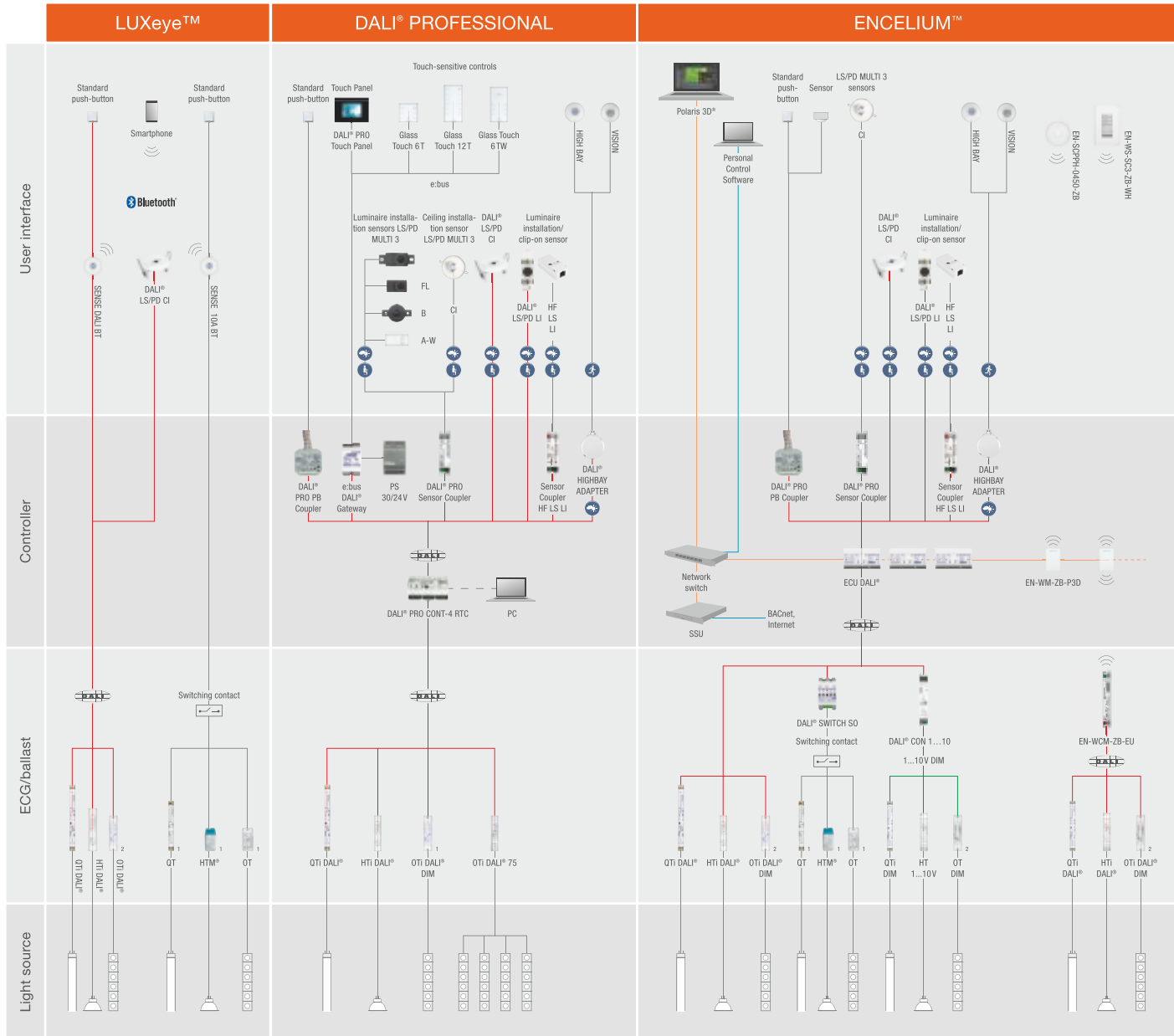

- Presence detection
 - Motion detection
 - Daylight detection
 - DALI®
 - 1...10V DIM
 - DMX
 - Powerline
 - EASY
 - ENCELIUM™ network
 - Customer network
- ¹ Non-dimmable OT, HT and OT control gears
² Suitable power supply required
³ Battery-less radio standard
⁴ Sensor with floating contact (e.g. DUO, VISION, HIGH BAY)

Odvojene napojne jedinice

Separated supply units

24V Napajanja / Power supplies

Art.	W	V	AxBxH
24V			
975	25W	24V	84x57x29,5
976	35W	24V	84x57x29,5
977	75W	24V	220x47x44
24V + DALI			
990	75W	24	220x46,2x43,6

IP65 Napajanja / Power supplies

Art.	W	V	AxBxH
IP65			
978	30W	230V	220x40x22
979	50W	230V	220x40x22
980	80W	230V	250x50x34
981	120W	230V	250x60x39
982	60W	230V	181x61,5x35
983	96W	230V	199x63x35,5
984	150W	230V	219x63x35,5

12V Napajanja / Power supplies

Art.	W	V	AxBxH
12V GU 5,3			
970	70W	12V	128x38x31
971	105W	12V	128x38x31

350mA Napajanja / Power supplies

Art.	W	V	AxBxH
350mA			
950	10W	350mA	80x40x21
951	15W	350mA	93x58x26,2
952	35W	350mA	103x67x29,7
350mA + DALI			
960	10W	350mA	105x70x28,3
961	15W	350mA	167x42x31
962	35W	350mA	120x70x28,3

700mA Napajanja / Power supplies











Art.	W	V	AxBxH
700mA			
953	10W	350mA	80x40x21
954	15W	350mA	93x58x26,2
955	35W	350mA	103x67x29,7
700mA + DALI			
963	10W	350mA	105x70x28,3
964	15W	350mA	105x70x28,3
965	35W	350mA	120x70x28,3

Opis simbola

Symbol description

Tehničke karakteristike

technical description

 IP40	stupanj zaštite svjetiljke <i>ingress protection level</i>		vrsta svjetiljke <i>type of luminaires</i>		0,5m	preporučena udaljenost svjetiljke <i>recommended lamp distance</i>
 IK08	stupanj mehaničke zaštite svjetiljke <i>IK impact test</i>		za ugradnju na normalno zapaljive površine <i>for mounting on normally flammable surfaces</i>		TC-GH	izvor svjetlosti <i>type of lamps</i>
	uređaj ispunjava zahtjeve E.E.A. <i>appliance complying with E.E.A. regulation</i>		uzemljenje klasa I <i>earth connection class I</i>		60°	širina svjetlosnog snopa <i>light beam angle</i>
	širina svjetlosnog snopa <i>light beam angle</i>		12,35 mm			preporučena debljina stropa za montažu <i>recommended ceiling thickness for installation</i>









Prema zahtjevu

On request

	EM 1h	Panik modul 1h u pripravnom spoju <i>Emergency light 1h non maintained</i>		Direkt/indirektna rasvjeta <i>Direct/indirect light</i>		Potezni prekidač <i>Pull switch</i>
	EM 3h	Panik modul 3h u pripravnom spoju <i>Emergency light 3h non maintained</i>		Daljinski upravljač <i>Remote control</i>		
	DALI	Regulacijska jedinica DALI <i>Regulative Unit DALI</i>		RGB boja svjetlosti <i>RGB light</i>		
	DIM	Regulacijska jedinica DIM <i>Regulative Unit DIM</i>		Difuzor u boji <i>Diffuser in color</i>		

Tablica

Table

	Artikl Code	šifra proizvoda za narudžbu <i>product code for ordering</i>		lm	svjetlosni tok u [lm] <i>luminous flux in [lm]</i>
	W	snaga svjetiljke u [W] <i>lamp power in [W]</i>		xH	dimenzije svjetiljke u [mm] <i>lamp dimensions in [mm]</i>
	K	temperatura svjetla u [K] <i>light temperature in [K]</i>			montažni otvor u [mm] <i>montage hole in [mm]</i>
	V	napajanje <i>power supply</i>		kg	težina svjetiljke u [kg] <i>lamp weight in [kg]</i>

Namjena

Use

	stambeni prostori <i>housing premises</i>		škole i konferencijske dvorane <i>schools and conference rooms</i>		bolnički prostori <i>hospital premises</i>
	industrijski prostori <i>industrial premises</i>		brodska namjena <i>ship purpose</i>		televizijski studiji <i>TV studios</i>
	dekorativni prostori <i>decorative premises</i>		skladišta <i>warehouses</i>		galerije <i>galleries</i>
	uredski prostori <i>office premises</i>		sportske dvorane <i>sport halls</i>		javne površine <i>public places</i>
	supermarketi i dućani <i>supermarkets and shops</i>		vanjski prostori <i>outdoor premises</i>		ulazni prostori, koridori <i>entrance halls, corridors</i>

Stupnjevi zaštite

Protection levels

IP zaštita (Ingress Protection) označava otpornost svjetiljke na krute i tekuće tvari.

1. znamenka određuje stupanj zaštite od krutih mehaničkih tijela i prašine
2. znamenka određuje stupanj zaštite od štetnog djelovanja tekućine

IP40	zaštita od krutih tijela <i>protection against solid objects</i>
0	nema zaštite <i>not protected</i>
1	zaštita od ulaska krutih tvari >50 mm <i>protection against solid objects >50 mm</i>
2	zaštita od ulaska krutih tvari >12,5 mm <i>protection against solid objects >12,5 mm</i>
3	zaštita od ulaska krutih tvari >2,5 mm <i>protection against solid objects >2,5 mm</i>
4	zaštita od ulaska krutih tvari >1 mm <i>protection against solid objects >1 mm</i>
5	zaštita od prašine <i>dust protected</i>
6	potpuna zaštita od prašine <i>dust tight</i>

IP protection (Ingress Protection) classifies and rates the degree of protection against intrusion, dust and water

- 1st digit indicates the level of protection against ingress of solid objects
2nd digit indicates the level of protection against harmful ingress of water

IP40	zaštita od tekućine <i>protection against liquids</i>
0	nema zaštite <i>not protected</i>
1	zaštita od kapanja vode <i>protection against dripping water</i>
2	zaštita od kapanja vode pod kutem 15° <i>protection against dripping water tilted to 15°</i>
3	zaštita od prskanja vode pod kutem do 60° <i>protection against spraying water tilted to 60°</i>
4	zaštita od prskanja vode <i>protection against spraying water</i>
5	zaštita od mlaza vode <i>protection against water jets</i>
6	zaštita od jakog mlaza vode <i>protection against powerful water jets</i>
7	zaštita od uronjavanja <i>protection against immersion</i>
8	zaštita od uronjavanja na dubini >1m <i>protection against immersion at >1m</i>

IK ocjena označava zaštitu od vanjskih mehaničkih udara. Tablica prikazuje ocjenu zaštite i energiju udara izraženu u [J].
IK rating indicates degrees of protection against external mechanical impacts. Table shows IK rating and impact energy in [J].

IK00	nema zaštite	IK06	Zaštita od udara snage 1 džula <i>Protected against 1 joules impact</i>
IK01	Zaštita od udara snage 0,14 džula <i>Protected against 0.14 joules impact</i>	IK07	Zaštita od udara snage 2 džula <i>Protected against 2 joules impact</i>
IK02	Zaštita od udara snage 0,20 džula <i>Protected against 0.20 joules impact</i>	IK08	Zaštita od udara snage 5 džula <i>Protected against 5 joules impact</i>
IK03	Zaštita od udara snage 0,35 džula <i>Protected against 0.35 joules impact</i>	IK09	Zaštita od udara snage 10 džula <i>Protected against 10 joules impact</i>
IK04	Zaštita od udara snage 0,50 džula <i>Protected against 0.50 joules impact</i>	IK10	Zaštita od udara snage 20 džula <i>Protected against 20 joules impact</i>
IK05	Zaštita od udara snage 0,70 džula <i>Protected against 0.70 joules impact</i>		

Vrste svjetiljaka

Type of luminaires

	Ugradna stropna svjetiljka Direktna uska distribucija Kut distribucije svjetla 10°- 25°	<i>Recessed wall mounted lamp Direct narrow distribution Light beam angle 10°- 25°</i>
	Ugradna stropna svjetiljka direktna srednja/široka distribucija Široki kut distribucije svjetlosti 25°- 40°	<i>Recessed wall mounted lamp Direct medium/wide distribution Light beam angle 25°- 40°</i>
	Ugradna stropna svjetiljka Izrazito široki kut distribucije 70°- 120°	<i>Recessed wall mounted lamp Direct wide distribution Light beam angle 70°- 120°</i>
	Ugradna stropna svjetiljka Izrazito široki kut distribucije svjetla 120°- 170°	<i>Recessed wall mounted lamp Direct wide/diffuse distribution Light beam angle 120°- 170°</i>
	Ugradni stropni wallwasher	<i>Recessed wall mounted wallwasher</i>
	Ugradni stropni reflektor Pomični kut distribucije svjetlosti Uska distribucija svjetla	<i>Recessed wall mounted directional spot Tiltable Narrow distribution</i>
	Ugradni stropni reflektor Pomični kut distribucije svjetlosti Osrednja distribucija	<i>Recessed wall mounted directional spot Tiltable Medium distribution</i>
	Ugradna zidna svjetiljka	<i>Recessed wall mounted lamp</i>
	Nadgradna stropna svjetiljka Direktna uska distribucija Kut distribucije svjetla 10°- 25°	<i>Surface mounted lamp Direct narrow distribution Light beam angle 10°- 25°</i>
	Nadgradna stropna svjetiljka direktna srednja/široka distribucija Široki kut distribucije svjetlosti 25°- 40°	<i>Surface mounted lamp Direct medium/wide distribution Light beam angle 25°- 40°</i>
	Nadgradna stropna svjetiljka Izrazito široki kut distribucije 70°- 120°	<i>Surface mounted lamp Direct wide distribution Light beam angle 70°- 120°</i>
	Nadgradna stropna svjetiljka Izrazito široki kut distribucije svjetla 120°- 170°	<i>Surface mounted lamp Direct wide/diffuse distribution Light beam angle 120°- 170°</i>
	Nadgradna stropna svjetiljka Izrazito široki kut distribucije svjetla 170°- 190°	<i>Surface mounted lamp Direct wide/diffuse distribution Light beam angle 170°- 190°</i>
	Nadgradni stropni wallwasher	<i>Surface mounted wallwasher</i>
	Nadgradna zidna svjetiljka	<i>Surface wall mounted lamp</i>
	Viseća svjetiljka Direktna uska distribucija Kut distribucije svjetla 10°- 25°	<i>Suspended lamp Direct narrow distribution Light beam angle 10°- 25°</i>
	Viseća svjetiljka direktna srednja/široka distribucija Široki kut distribucije svjetlosti 25°- 40°	<i>Suspended lamp Direct medium/wide distribution Light beam angle 25°- 40°</i>
	Viseća svjetiljka Izrazito široki kut distribucije 70°- 120°	<i>Suspended lamp Direct wide distributio Light beam angle 70°- 120°</i>
	Viseća stropna svjetiljka Izrazito široki kut distribucije svjetla 170°- 190°	<i>Suspended lamp Direct wide/diffuse distribution Light beam angle 170°- 190°</i>

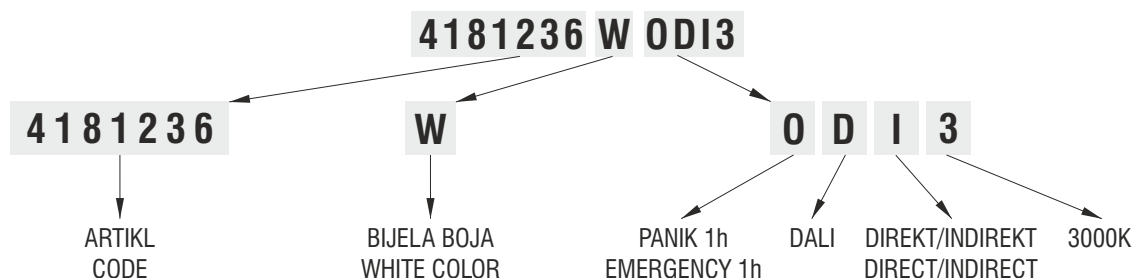
Upute za naručivanje / *Ordering instructions*Primjer gotovog artikla / *Example of finished Code:***Boja / Color**
 Upisati oznaku boje
Enter color code

<p>4181236</p> <p>W</p> <p>G</p> <p>B</p> <p>S</p> <p>A</p> <p>N</p> <p>K</p> <p>Z</p> <p>R</p> <p>Y</p> <p>H</p> <p>E</p> <p>U</p> <p>F</p>	<p>4181236WODI3 Bijela / <i>White</i></p> <p>4181236GODI3 Siva fino strukturna / <i>Grey fine structural</i></p> <p>4181236BODI3 Crna / <i>Black</i></p> <p>4181236SODI3 Siva / <i>Grey</i></p> <p>4181236AODI3 Anodizirani aluminij / <i>Anodized aluminium</i></p> <p>4181236NODI3 Prozirna / <i>Transparent</i></p> <p>4181236KODI3 Krom / <i>Chrome</i></p> <p>4181236ZODI3 Pozlata / <i>Gilded</i></p> <p>4181236RODI3 Crvena / <i>Red</i></p> <p>4181236YODI3 Žuta / <i>Yellow</i></p> <p>4181236HODI3 Ljubičasta / <i>Purple</i></p> <p>4181236EODI3 Zelena / <i>Green</i></p> <p>4181236UODI3 Plava / <i>Blue</i></p> <p>4181236FODI3 Narandžasta / <i>Orange</i></p>
--	---

Prema zahtjevu / *On request*
 Upisati željene oznake po redosljedu
Enter desired codes in order

<p>4181236W</p> <p> = O</p> <p> = T</p> <p> = D</p> <p> = M</p> <p> = I</p> <p> = C</p> <p> = L</p> <p>P</p> <p> = X</p> <p> = V</p> <p>2</p> <p>3</p> <p>4</p> <p>5</p> <p>6</p> <p>V</p> <p>Q</p>	<p>4181236WODI3 Panik modul 1h u pripravnom spoju / <i>Emergency light 1h non maintained</i></p> <p>4181236WTDI3 Panik modul 3h u pripravnom spoju / <i>Emergency light 3h non maintained</i></p> <p>4181236WDDI3 Regulacijska jedinica DALI / <i>Regulative Unit DALI</i></p> <p>4181236WMI3 Regulacijska jedinica DIM / <i>Regulative Unit DIM</i></p> <p>4181236WODI3 Direkt/indirektna rasvjeta / <i>Direct/indirect light</i></p> <p>4181236WODC3 RGB boja svjetlosti / <i>RGB light</i></p> <p>4181236WODL3 Difuzor u boji / <i>Diffuser in color</i></p> <p>4181236WODP3 Boja za ekstremno agresivne uvjete / <i>Color for extreme conditions</i></p> <p>4181236WODX3 Kućiste od inox-a AISI 316 / <i>Housing from inox AISI 316</i></p> <p>4181236WODV3 Polikarbonatni difuzor za HACCP / <i>polycarbonate diffuser for HACCP</i></p> <p>4181236WODI2 Temperatura svjetlosti 2700K / <i>Color temperature 2700K</i></p> <p>4181236WODI3 Temperatura svjetlosti 3000K / <i>Color temperature 3000K</i></p> <p>4181236WODI4 Temperatura svjetlosti 4000K / <i>Color temperature 4000K</i></p> <p>4181236WODI5 Temperatura svjetlosti 5000K / <i>Color temperature 5000K</i></p> <p>4181236WODI6 Temperatura svjetlosti 6500K / <i>Color temperature 6500K</i></p> <p>4181236WODIV DMX</p> <p>4181236WODIQ CRI >93</p>
--	---

Art.	pg.	Art.	pg.	Art.	pg.	Art.	pg.	Art.	pg.	Art.	pg.	Art.	pg.	Art.	pg.
2001218	63	2214124	62	2401124	132	2451712	153	2592713	151	3161113	110	3282232	122	3322703	130
2001219	63	2214125	62	2401128	132	2471700	152	2592714	151	3161118	110	3282701	122	3322704	130
2001226	63	2214128	62	2401135	132	2471701	152	2592715	151	3161126	110	3282702	122	3322705	130
2001237	63	2214129	62	2401139	132	2471702	152	2592716	151	3161132	110	3282703	122	3332101	94
2001437	63	2214135	62	2401149	132	2471703	152	2612701	154	3161142	110	3302218	126	3332201	95
2001711	63	2214136	62	2401154	132	2501114	146	2612702	154	3161213	110	3302226	126	3332301	97
2001712	63	2214139	62	2401706	133	2501115	146	2612703	154	3161218	110	3302232	126	3332401	98
2001721	63	2214140	62	2401713	133	2501118	146	2612704	154	3161226	110	3302414	126	3332711	94
2001731	63	2214149	62	2401719	133	2501121	146	2631731	158	3161232	110	3302424	126	3332712	94
2001732	63	2214150	62	2401725	133	2501124	146	2631732	158	3161242	110	3302701	126	3332713	94
2003218	64	2214154	62	2401731	133	2501128	146	2631733	158	3161717	111	3302702	126	3332714	94
2003219	64	2214155	62	2401737	133	2501130	146	2641731	158	3161726	111	3302703	126	3332715	94
2003226	64	2291114	142	2402114	135	2501135	146	2641732	158	3202749	114	3302705	126	3332721	95
2003237	64	2291124	142	2402121	135	2501136	146	2641733	158	3212700	100	3302706	126	3332722	95
2003437	64	2291128	142	2402124	135	2501139	146	2641702	158	3212701	100	3302707	126	3332723	95
2141114	138	2291135	142	2402128	135	2501149	146	2747712	162	3242050	89	3302741	126	3332724	95
2141121	138	2291149	142	2402135	135	2501154	146	2747772	162	3242711	89	3302742	126	3332725	95
2141124	138	2291154	142	2402139	135	2501158	146	2747752	162	3242713	89	3302743	126	3332731	97
2141128	138	2291180	142	2402149	135	2501180	146	3121001	82	3252100	90	3312022	129	3332732	97
2141135	138	2301114	143	2402154	135	2501214	146	3121002	82	3252135	90	3312040	129	3332733	97
2141139	138	2301124	143	2402706	136	2501221	146	3121003	82	3252170	90	3312055	129	3332734	97
2141149	138	2301128	143	2402712	136	2501224	146	3132118	116	3252701	90	3312218	129	3332735	97
2141154	138	2301135	143	2402713	136	2501228	146	3132126	116	3252702	90	3312226	129	3332741	98
2141711	139	2301149	143	2402719	136	2554705	149	3132132	116	3252718	90	3312232	129	3332742	98
2141712	139	2301154	143	2402722	136	2554707	149	3132218	116	3252723	90	3312710	129	3332743	98
2141721	139	2301180	143	2402725	136	2554715	149	3132226	116	3252734	90	3312713	129	3332744	98
2141722	139	2301711	143	2402731	136	2554716	149	3132232	116	3262050	120	3312703	129	3332745	98
2141731	139	2301712	143	2402732	136	2581701	148	3132711	117	3262711	120	3312704	129	3342149	92
2141732	139	2301721	143	2402737	136	2581702	148	3132712	117	3262713	120	3312706	129	3342150	92
2141741	139	2301722	143	2402742	136	2581703	148	3132713	117	3272050	121	3322122	130	3342249	92
2141742	139	2301731	143	2431712	155	2581704	148	3142218	116	3272711	121	3322140	130	3342250	92
2214114	62	2301732	143	2441705	157	2592701	150	3142226	116	3272713	121	3322155	130	3342349	92
2214115	62	2301741	143	2451700	153	2592702	150	3142232	116	3282213	122	3322218	130	3342350	92
2214121	62	2401114	132	2451701	153	2592703	150	3142721	117	3282218	122	3322226	130	3342449	92
2214122	62	2401121	132	2451702	153	2592704	150	3142722	117	3282226	122	3322232	130	3342450	92

Art.	pg.	Art.	pg.	Art.	pg.	Art.	pg.	Art.	pg.	Art.	pg.	Art.	pg.	Art.	pg.
3342710	92	3492221	127	3802118	106	4181711	50	4253050	30	4363741	20	4441624	12	4443614	16
3342720	92	3492224	127	3802126	106	4181721	50	4253080	30	4363742	20	4441710	12	4443624	16
3342730	92	3492228	127	3802132	106	4181731	50	4253711	30	4363751	20	4441716	12	4443710	13
3342740	92	3492235	127	3802142	106	4181741	50	4253712	30	4363752	20	4441731	10	4443716	13
3401701	79	3492239	127	3802213	106	4181751	50	4253721	30	4378027	70	4441732	10	4443731	13
3401702	79	3492249	127	3802218	106	4184060	51	4253722	30	4393050	31	4441741	10	4443732	13
3401703	79	3492254	127	3802226	106	4184100	51	4261050	34	4393080	31	4441742	10	4443741	13
3401704	79	3492280	127	3802232	106	4184113	51	4261710	34	4393711	31	4441761	10	4443742	13
3411701	80	3492711	128	3802242	106	4184126	51	4261711	34	4393712	31	4441763	10	4443761	13
3411702	80	3492712	127	3802717	108	4184232	51	4264050	35	4393721	31	4441781	10	4443763	13
3411703	80	3492721	128	3802726	108	4184260	51	4264250	35	4393722	31	4441783	10	4443781	13
3411704	80	3492722	128	3802732	108	4201118	58	4278140	37	4413427	22	4441821	12	4443783	13
3411705	80	3492723	127	4041150	44	4201122	58	4294060	73	4413527	22	4441839	12	4443821	16
3411706	80	3492724	127	4041250	46	4201126	58	4308060	74	4413741	22	4441892	12	4443839	16
3411707	80	3492731	128	4043150	47	4201127	58	4318060	75	4413742	22	4442040	18	4443892	16
3411708	80	3492732	128	4043250	47	4201132	58	4323527	21	4413751	22	4442055	18	4513027	26
3431706	41	3492733	127	4044150	44	4201142	58	4323727	21	4413752	22	4442194	18	4513717	26
3431708	41	3492734	127	4044250	46	4201218	58	4323751	21	4423327	23	4442218	18	4513726	26
3431710	41	3502715	103	4044251	48	4201226	58	4323752	21	4423527	23	4442324	18	4513732	26
3452049	86	3502725	103	4121022	67	4201227	58	4323771	21	4423731	23	4442614	18	4513734	26
3452711	86	3502735	103	4121222	67	4201232	58	4323772	21	4423732	23	4442624	18	7246703	160
3452712	86	3502745	103	4121322	67	4201242	58	4343711	32	4423751	23	4442731	17	7246706	160
3472049	86	3512715	104	4172701	84	4201327	58	4343712	32	4423752	23	4442732	17	7254730	166
3472711	86	3512725	104	4172703	84	4201721	59	4343215	32	4433227	24	4442741	17	7254731	166
3472712	86	3512735	104	4172705	84	4201725	59	4343242	32	4433327	24	4442742	17	7254732	166
3492114	128	3512745	104	4181060	50	4201731	59	4343270	32	4433721	24	4442761	17	7258730	170
3492121	128	3524721	54	4181100	50	4201735	59	4343275	32	4433722	24	4442763	17	7258731	170
3492124	128	3524722	54	4181113	50	4201745	59	4353711	33	4433731	24	4442781	17	7258732	170
3492128	128	3534721	55	4181118	50	4201872	58	4353712	33	4433732	24	4442783	17	7268730	171
3492139	128	3534722	55	4181218	50	4251050	29	4353215	33	4441040	12	4442892	18	7268731	171
3492135	128	3542150	93	4181226	50	4251080	29	4353242	33	4441055	12	4443040	16	7268751	172
3492149	128	3542149	93	4181232	50	4251711	29	4353270	33	4441194	12	4443055	16	7268755	172
3492154	128	3542711	93	4181260	50	4251712	29	4353275	33	4441218	12	4443194	16	7278730	167
3492180	128	3542713	93	4181275	50	4251721	29	4363427	20	4441324	12	4443218	16	7348715	164
3492214	127	3802113	106	4181360	50	4251722	29	4363527	20	4441614	12	4443324	16	7348725	164

ELTOR

IDEAS IN LIGHTING

ELTOR d.o.o.
Industrijska Ulica 18, Lovrin
52 000 Pazin - Croatia
Tel.: 00 385 52 622 832
Fax.: 00 385 52 621 298
eltor@eltor.hr
www.eltor.hr

Odricanje:

Sve informacije sadržane u ovom dokumentu su sakupljene, analizirane i verificirane sa velikom pažnjom od strane ELTOR-a. ELTOR d.o.o. nije odgovoran za točnost i cjelovitost informacija sadržanih u ovom dokumentu i ELTOR se nemože smatrati odgovornim sa bilo kakvu štetu nastalu kao posljedica korištenja sadržaja ovog dokumenta.

Fotografije i sadržaj ovog dokumenta vlasništvo su ELTOR-a te je zabranjeno kopiranje i korištenje istih bez pisanog dopuštenja od strane ELTOR-a.

Disclaimer:

All information contained in this document has been collected, analyzed and verified with great care by ELTOR. ELTOR d.o.o. is not responsible for the correctness and completeness of the information contained in this document and ELTOR cannot be made liable for any damage that occurs in connection with the use of and / or reliance on the content of this document.

All the content and photography in this document is owned by ELTOR and it's usage or copying is forbidden without prior written consent from ELTOR.



www.eltor.hr